



**SIZE 2-20
PATTERN
SIZE KEY**

2	—————
4	- - - - -
6
8	- . - . -
10
12	- . - . -
14
16	- . - . -
18
20	- . - . -

SYMBOL KEY

- grainline arrow 
- match point/
placement mark
- ⊕ bust apex

STUDY HALL DRESS

Sizes 2–20
with cup sizes A–H

5/8 inch (in) (1.5 cm) seam allowances
are included on all pattern pieces.

**2 cm
test
square**

**1 in
test
square**

PAGE

© 2024 Charm Patterns by Gertie
Distribution and Commercial Use Prohibited

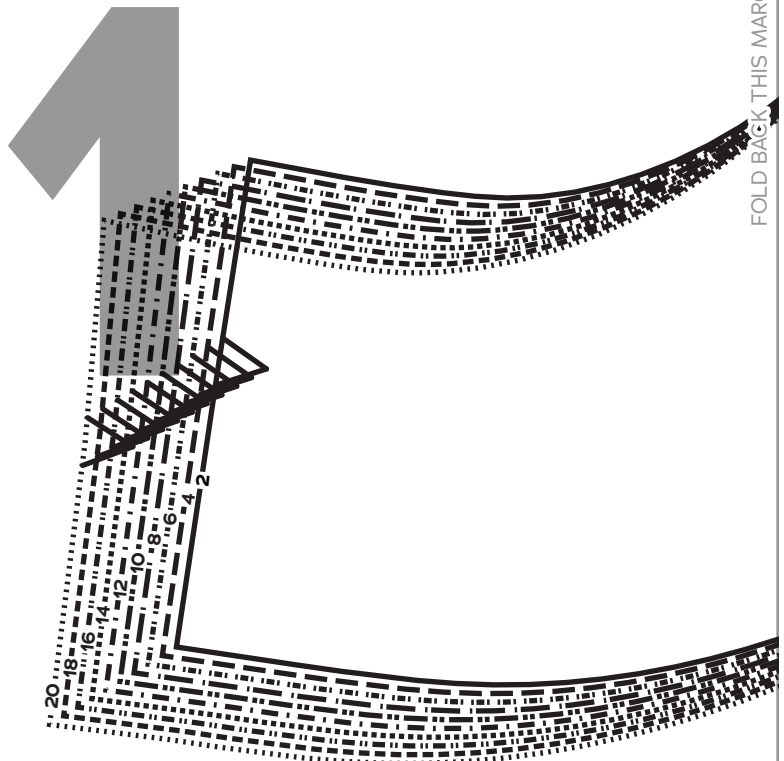

FOLD BACK THIS MARGIN

FOLD BACK THIS MARGIN

A1

PAGE

2

Front Neck Facing
Cut 1 fabric on fold,
1 interfacing on fold

9 STUDY HALL DRESS SIZES 2-20

Charm Patterns BY GERTIE

FOLD

FOLD BACK THIS MARGIN

A1

FOLD BACK THIS MARGIN

A2

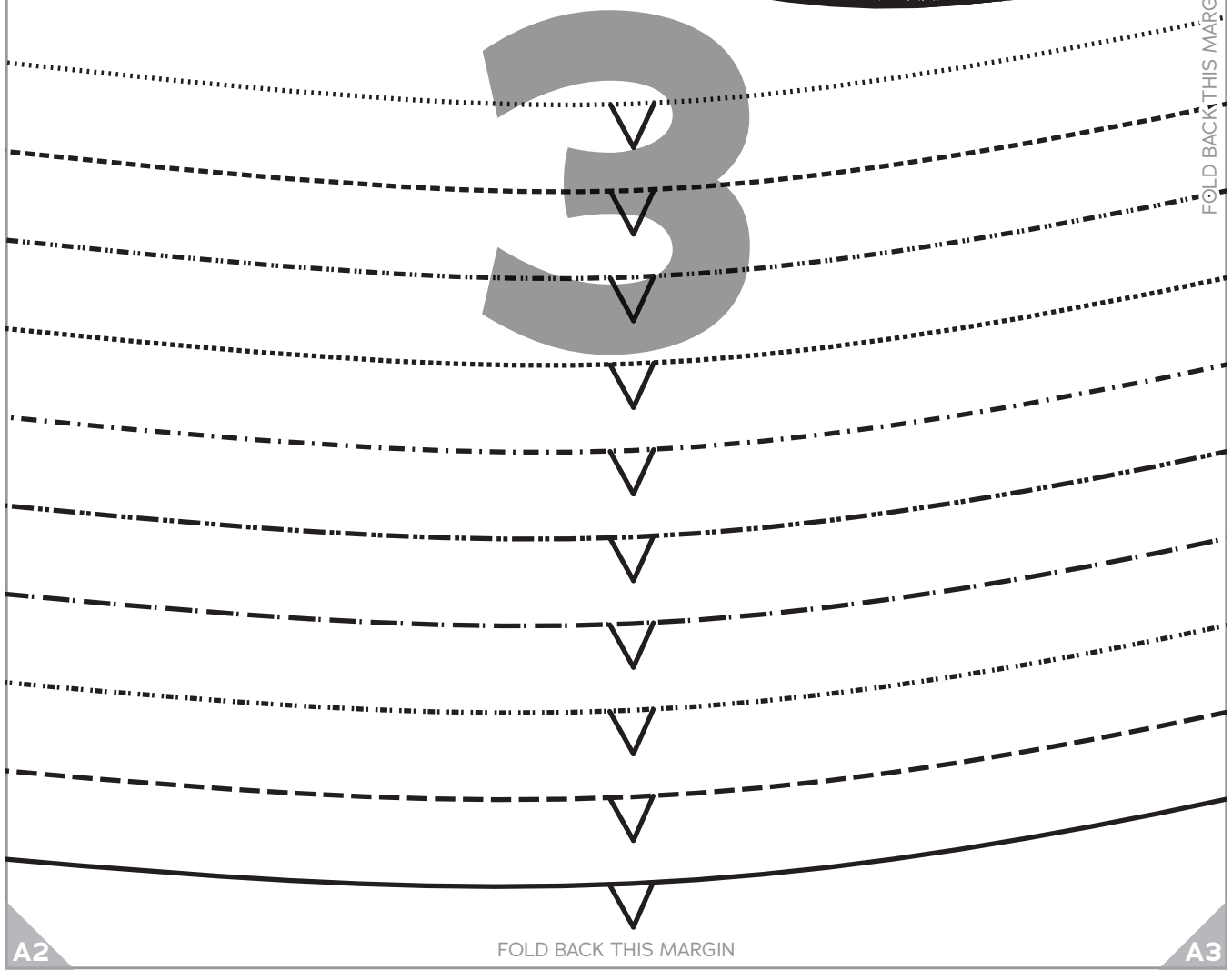
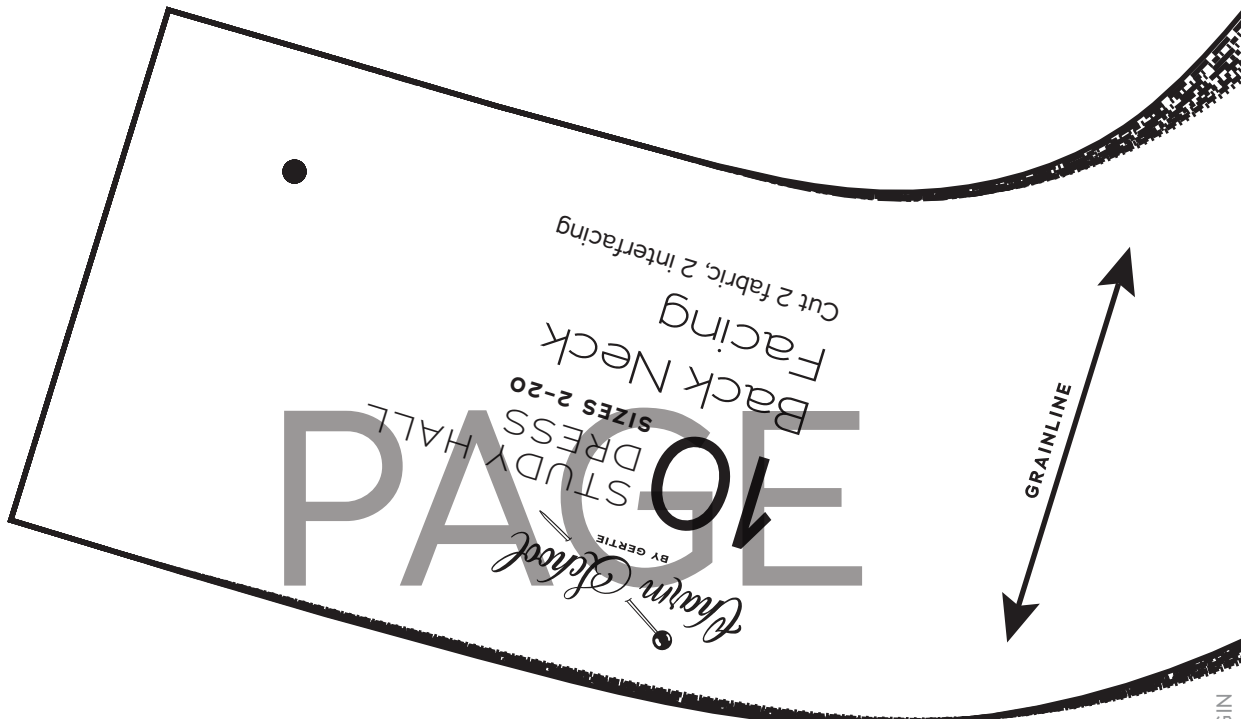

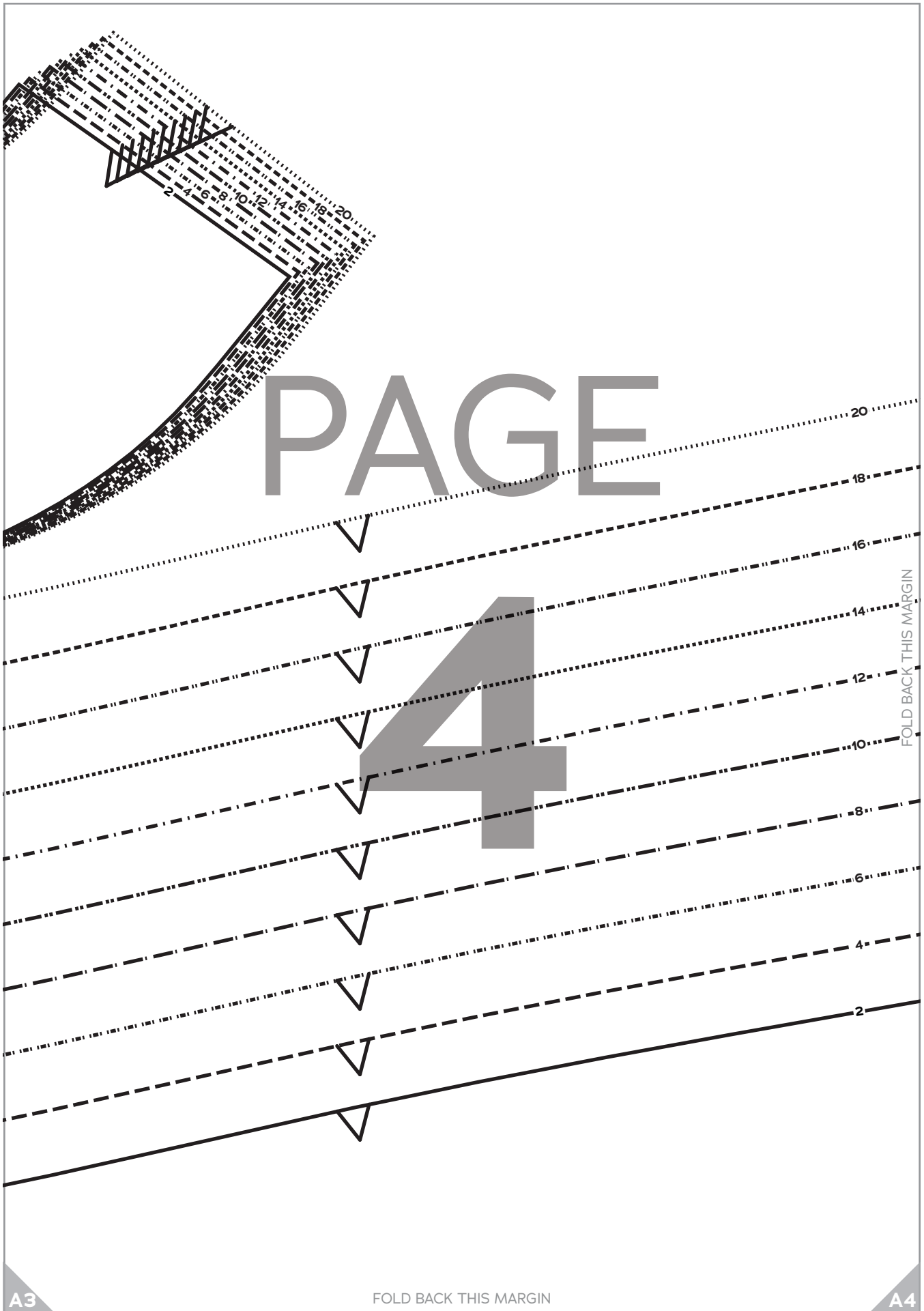

PAGE

4

FOLD BACK THIS MARGIN

FOLD BACK THIS MARGIN

A3

A4

PAGE

5

FOLD BACK THIS MARGIN

A4

FOLD BACK THIS MARGIN

A5

PAGE

6

FOLD BACK THIS MARGIN

A5

FOLD BACK THIS MARGIN

A6

POCKET
OPENING

PAGE

7

FOLD BACK THIS MARGIN

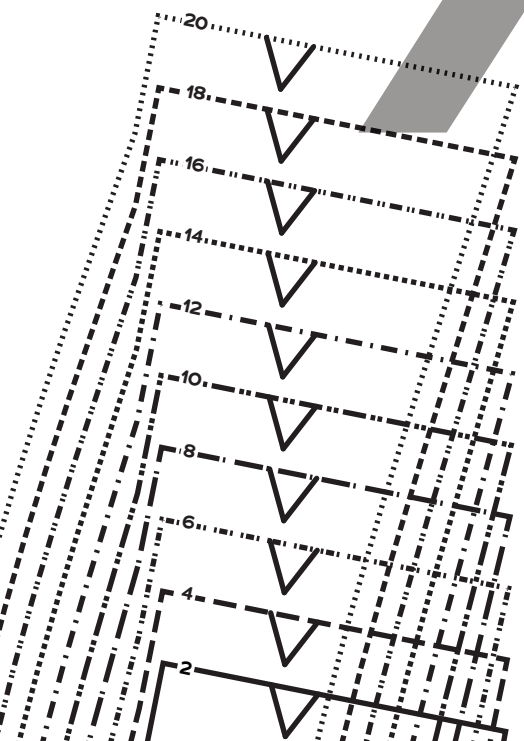

A6

FOLD BACK THIS MARGIN

A7



STUDY HALL
DRESS
SIZES 2-20

3

Pocket Bag

Cut 2 lining

GRAINLINE

PAGE

8

FOLD BACK THIS MARGIN

A7

FOLD BACK THIS MARGIN

A8

PAGE

9

Charm School
 BY GERTIE
 8 STUDY HALL
 DRESS
 sizes 2-20
 Undercollar
 cut 2 fabric

FOLD BACK THIS MARGIN

FOLD BACK THIS MARGIN

A8

A9

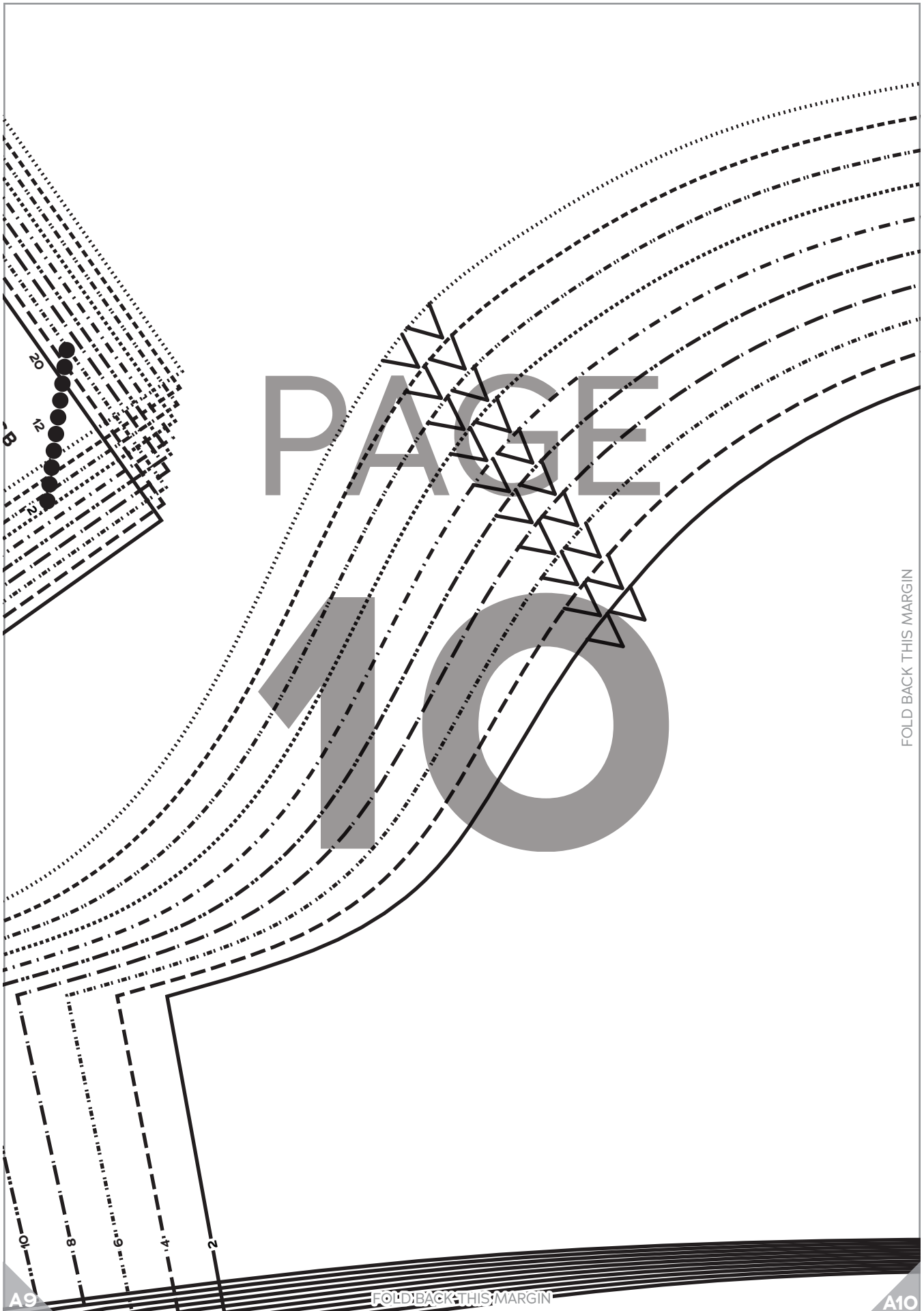

PAGE
10

FOLD BACK THIS MARGIN

FOLD BACK THIS MARGIN

A9

A10

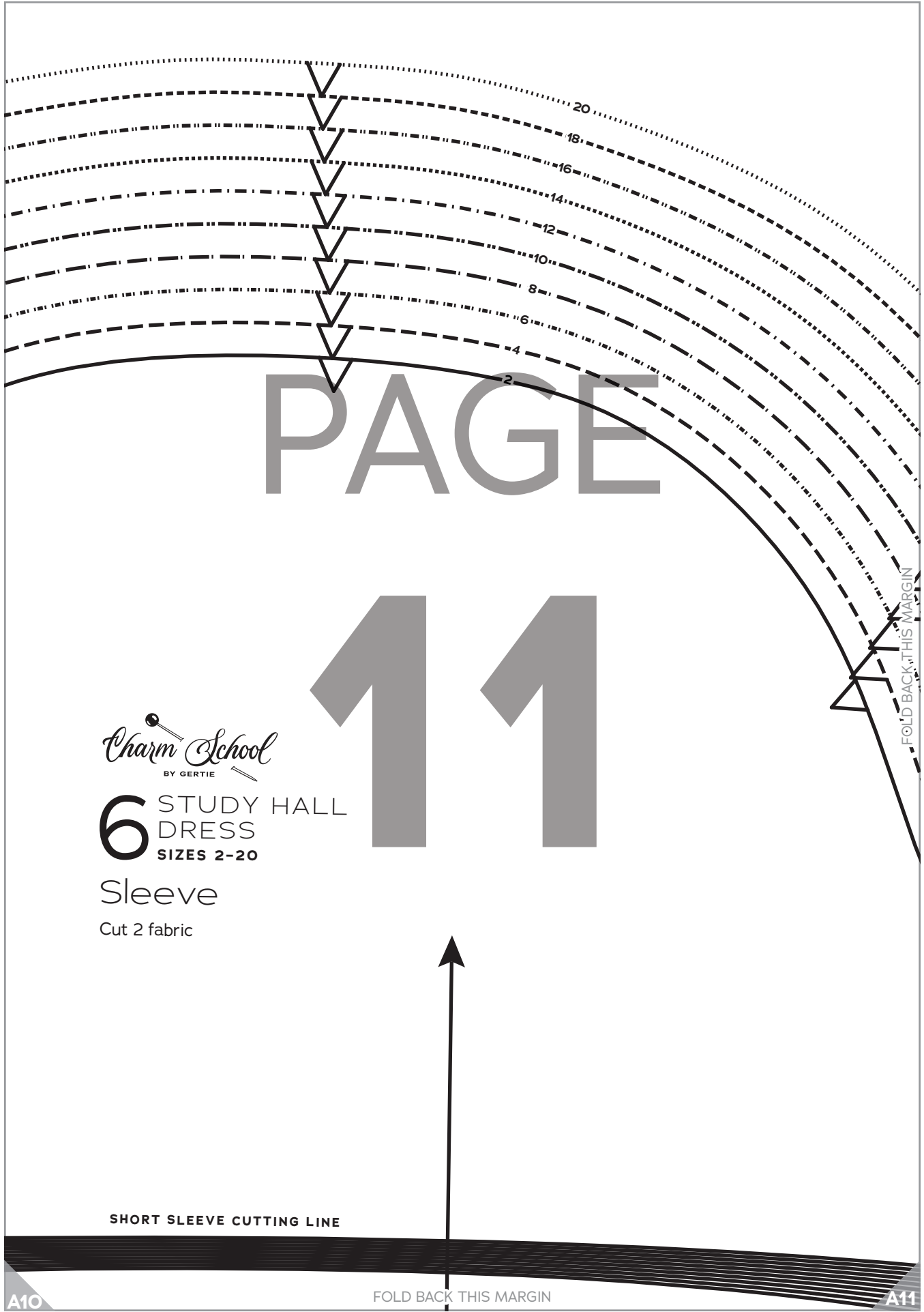

PAGE

11

Charm School
BY GERTIE

6 STUDY HALL
DRESS
SIZES 2-20

Sleeve

Cut 2 fabric

SHORT SLEEVE CUTTING LINE

FOLD BACK THIS MARGIN

FOLD BACK THIS MARGIN

A10

A11

PAGE 12

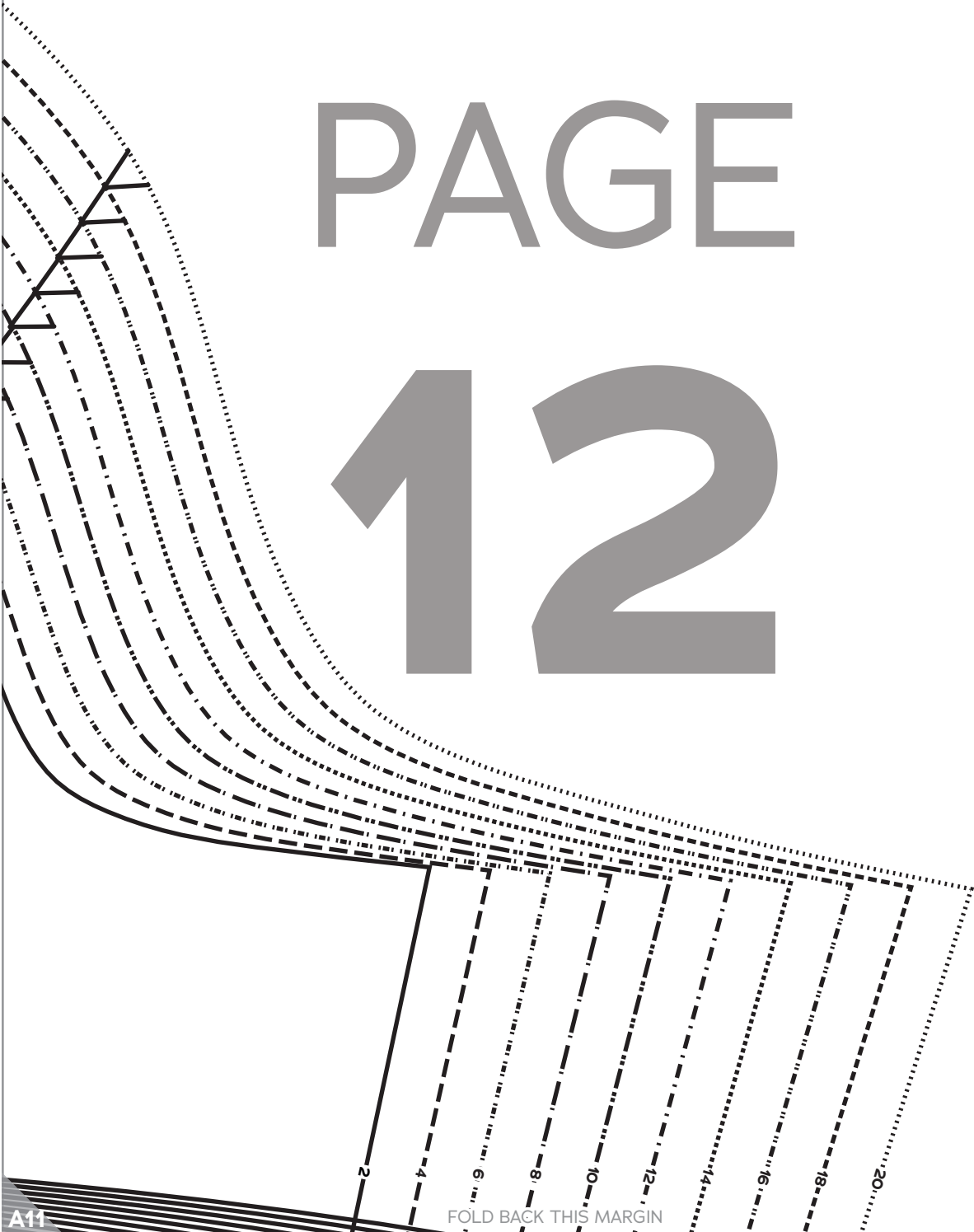

A11

FOLD BACK THIS MARGIN

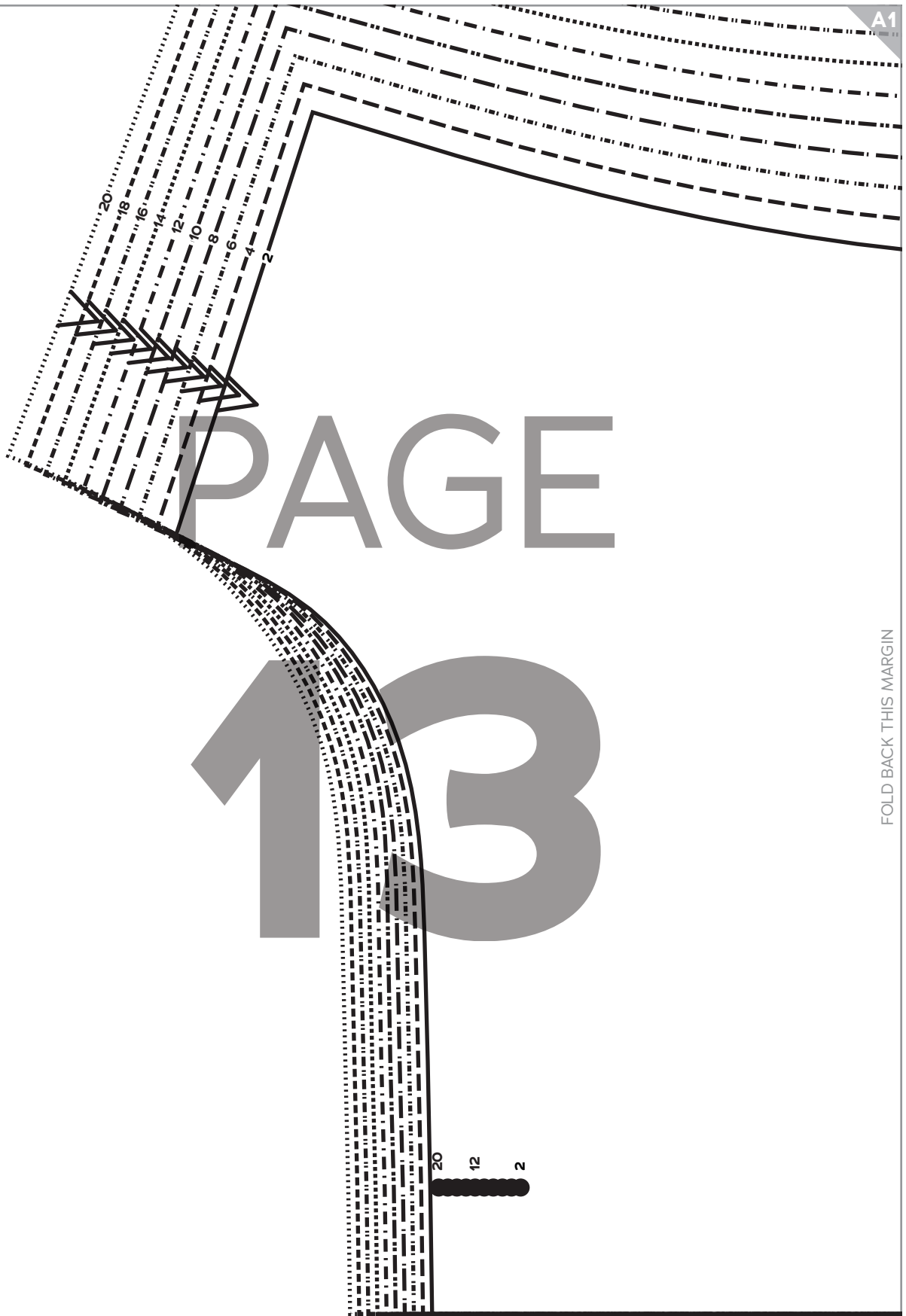

PAGE
13

FOLD BACK THIS MARGIN

FOLD BACK THIS MARGIN

A1

A2

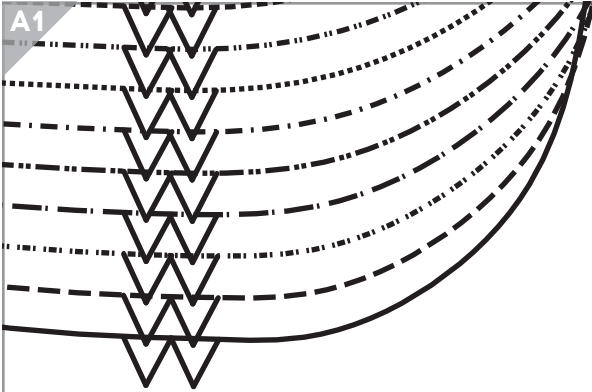

PAGE

14

Charm School
BY GERTIE

STUDY HALL
DRESS
SIZES 2-20

Dress Back
Cut 2 fabric

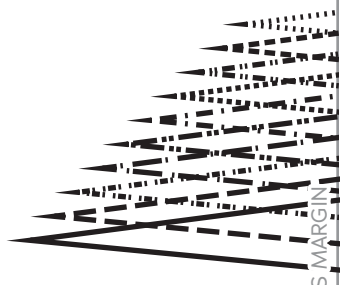

FOLD BACK THIS MARGIN

B1

B2

FOLD BACK THIS MARGIN

A2

A3

GRAINLINE

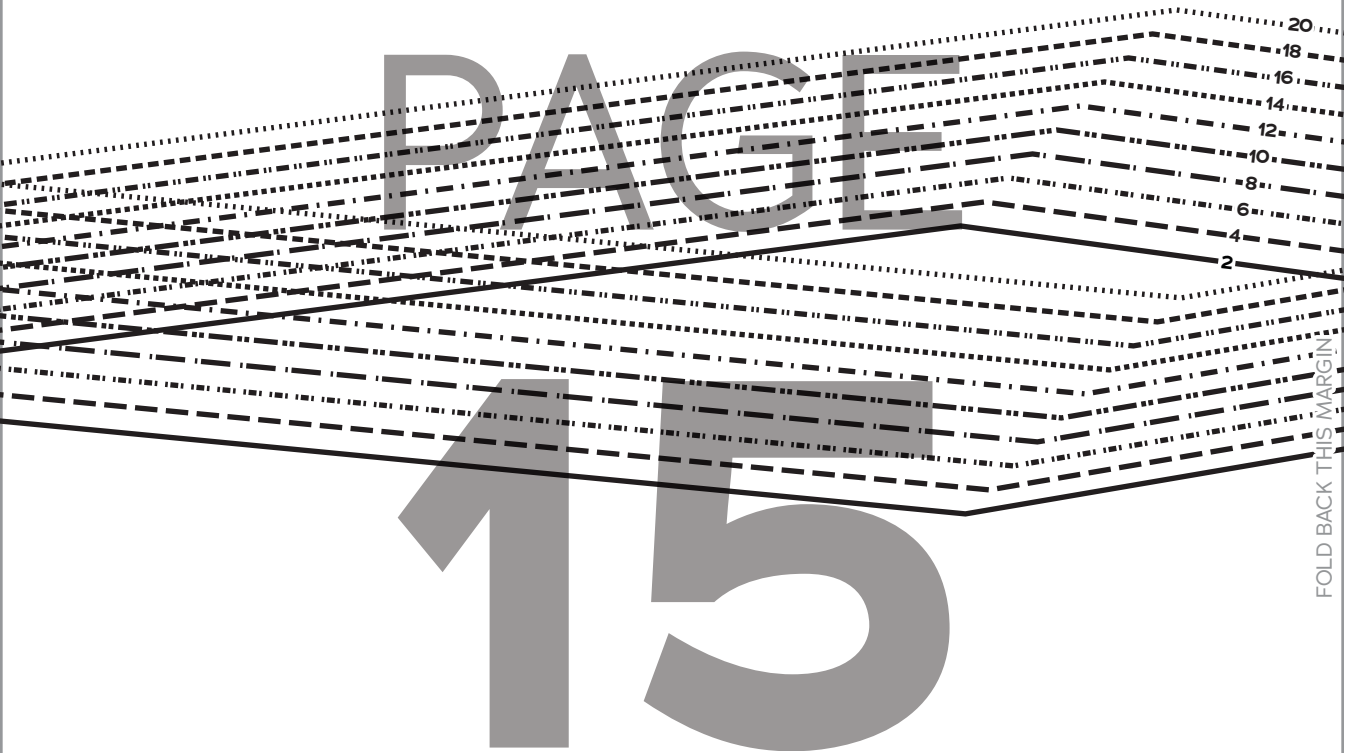

FOLD BACK THIS MARGIN

B2

FOLD BACK THIS MARGIN

B3

A3

A4



PAGE 16

FOLD BACK THIS MARGIN

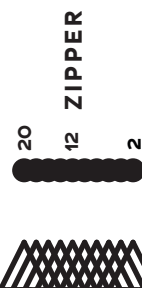

B3

FOLD BACK THIS MARGIN

B4

A4

A5

PAGE

17

FOLD BACK THIS MARGIN

B4

FOLD BACK THIS MARGIN

B5

A5

A6

PAGE

18

SHORT SKIRT CUTTING LINE

FOLD BACK THIS MARGIN

B5

FOLD BACK THIS MARGIN

B6

A6

A7



4 STUDY HALL DRESS SIZES 2-20

Pocket Interfacing Cut 2 interfacing

PAGE 19

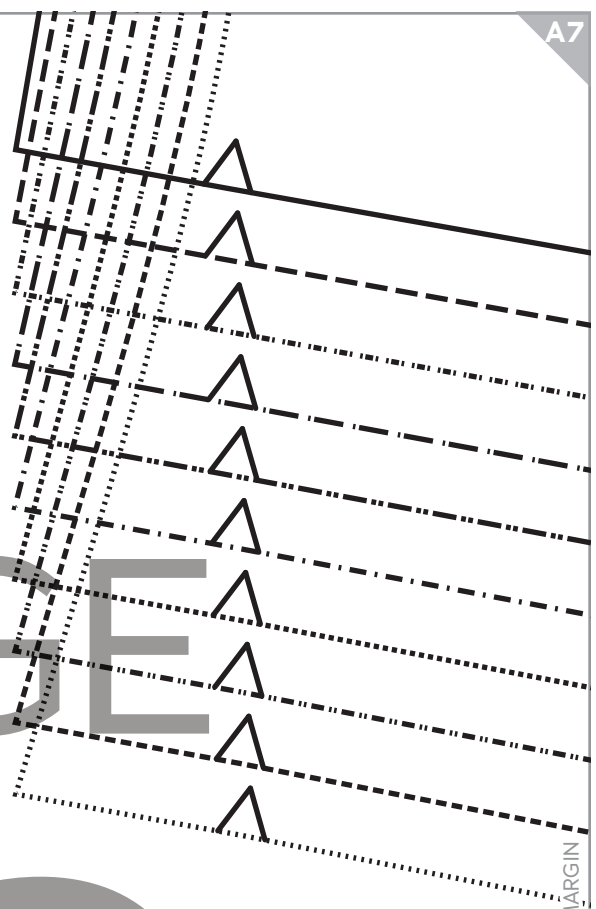

FOLD BACK THIS MARGIN



B6

FOLD BACK THIS MARGIN

B7

A7

A8

PAGE

20

FOLD BACK THIS MARGIN

FOLD BACK THIS MARGIN

B7

B8

A8

A9

PAGE 21

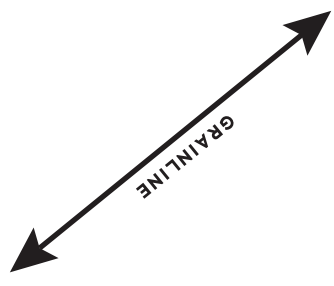

CF ●

CF ●

FOLD BACK THIS MARGIN

FOLD BACK THIS MARGIN

B8

B9

A9

A10

PAGE 22

FOLD BACK THIS MARGIN

B9

FOLD BACK THIS MARGIN

B10

A10

A11

GRAINLINE

PAGE
23

FOLD BACK THIS MARGIN

B10

FOLD BACK THIS MARGIN

B11

A11

PAGE

24

B11

FOLD BACK THIS MARGIN

PAGE

25

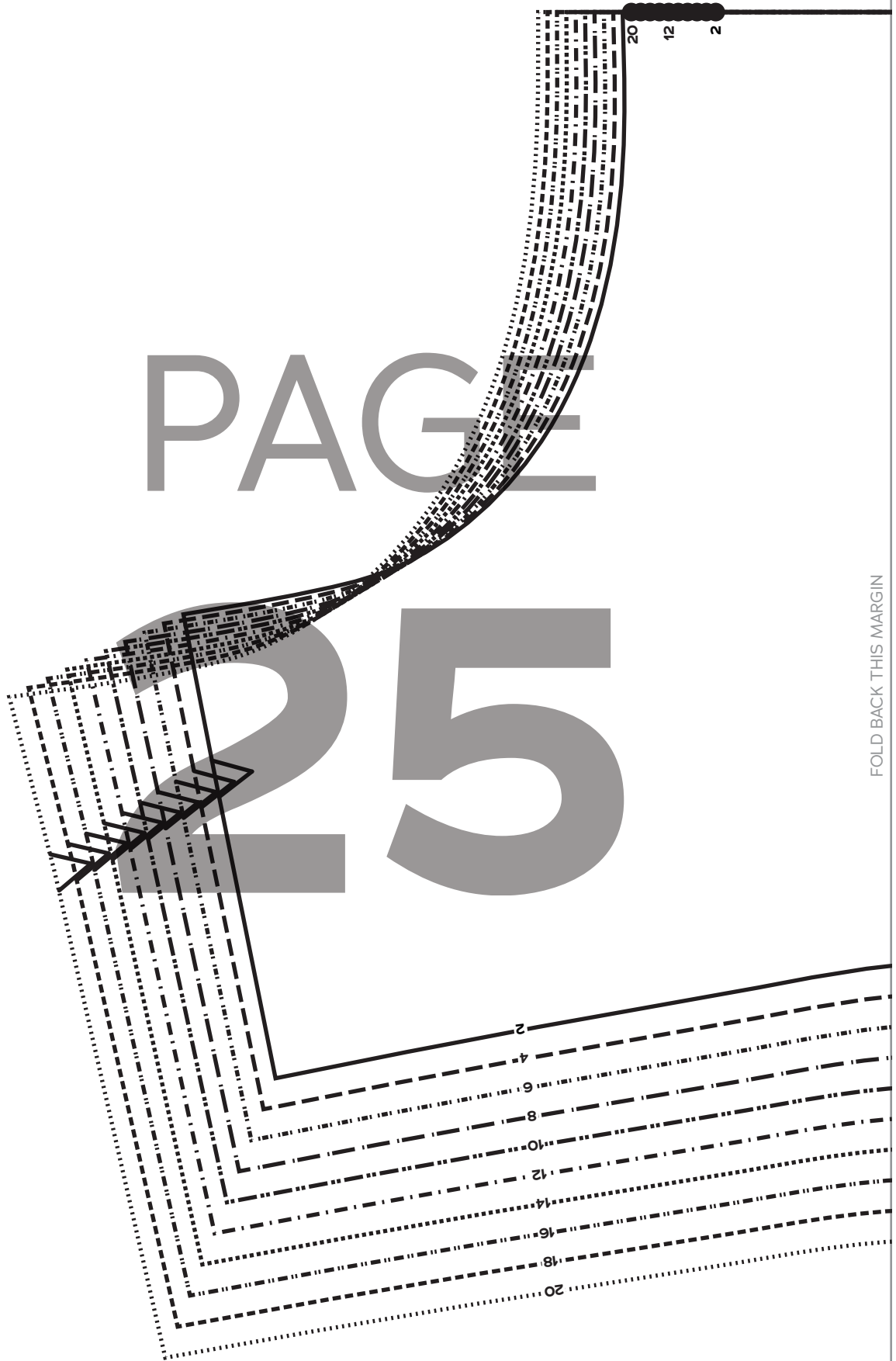

FOLD BACK THIS MARGIN

FOLD BACK THIS MARGIN



1 STUDY HALL DRESS SIZES 2-20

Dress Front, A-C Cup
Cut 1 fabric on fold

PAGE 20

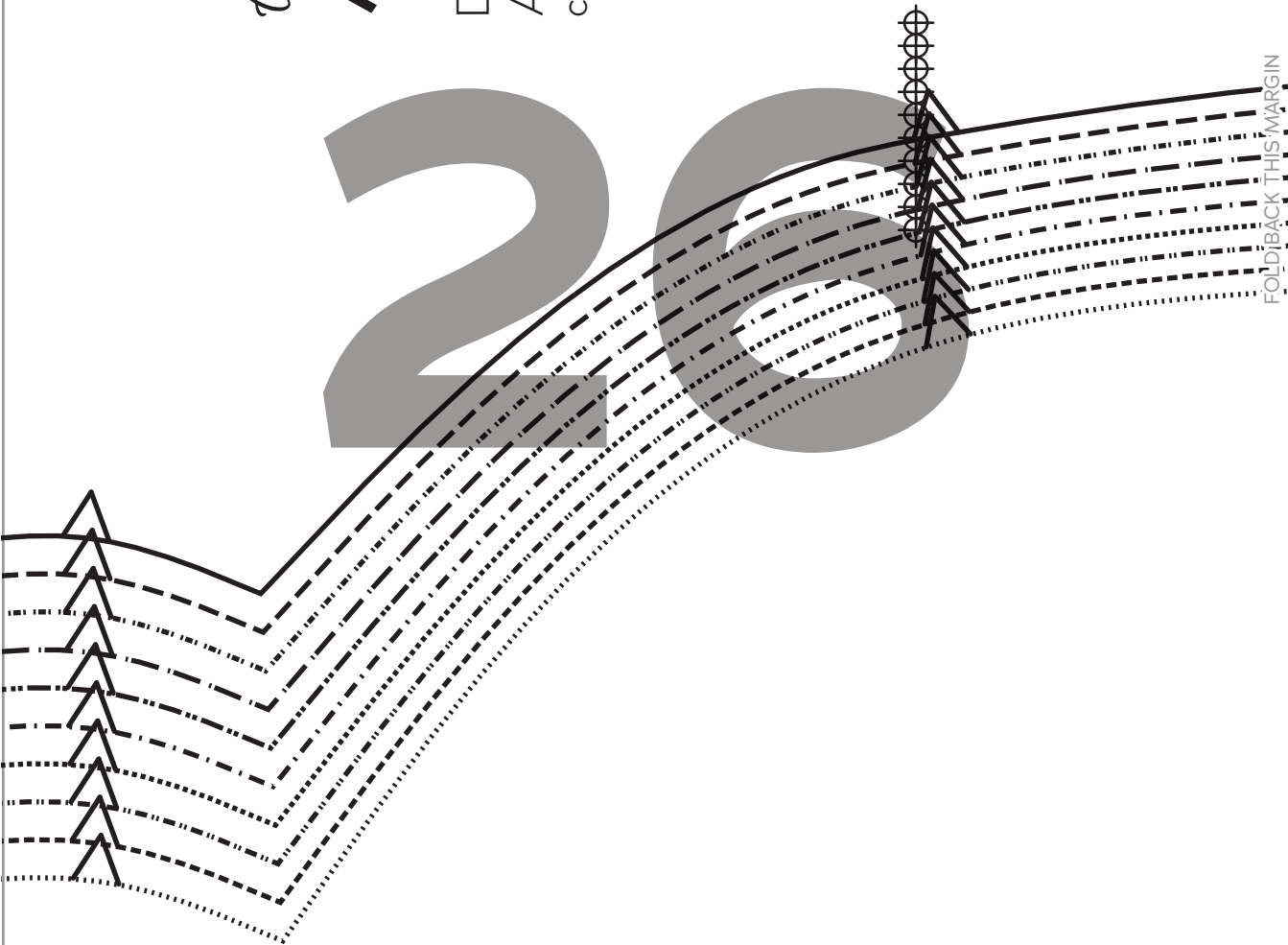

FOLD BACK THIS MARGIN

B2

B3



FOLD

PAGE

POCKET
OPENING

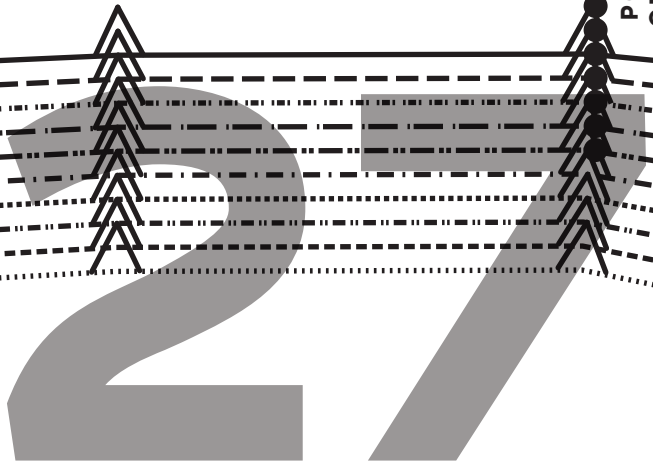

FOLD BACK THIS MARGIN

C2

FOLD BACK THIS MARGIN

C3

B3

B4



PAGE

28

FOLD BACK THIS MARGIN

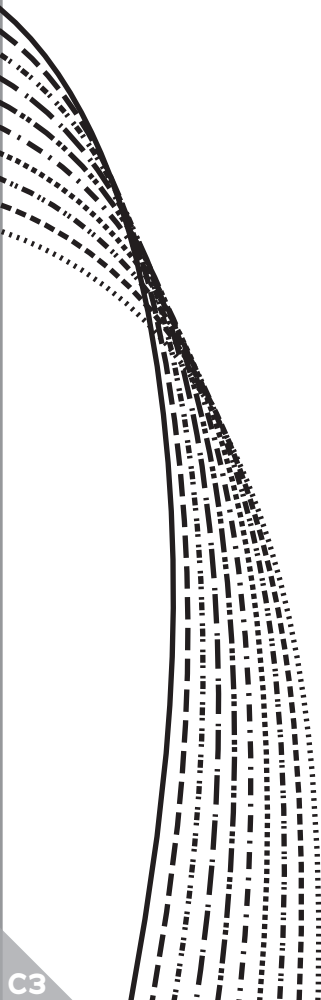

C3

FOLD BACK THIS MARGIN

C4

B4

B5

PAGE

29

FOLD BACK THIS MARGIN

C4

FOLD BACK THIS MARGIN

C5

B5

B6

PAGE

30

SHORT SKIRT CUTTING LINE

FOLD BACK THIS MARGIN

C5

FOLD BACK THIS MARGIN

C6

B6

B7

PAGE

31

FOLD BACK THIS MARGIN



C6

FOLD BACK THIS MARGIN

C7

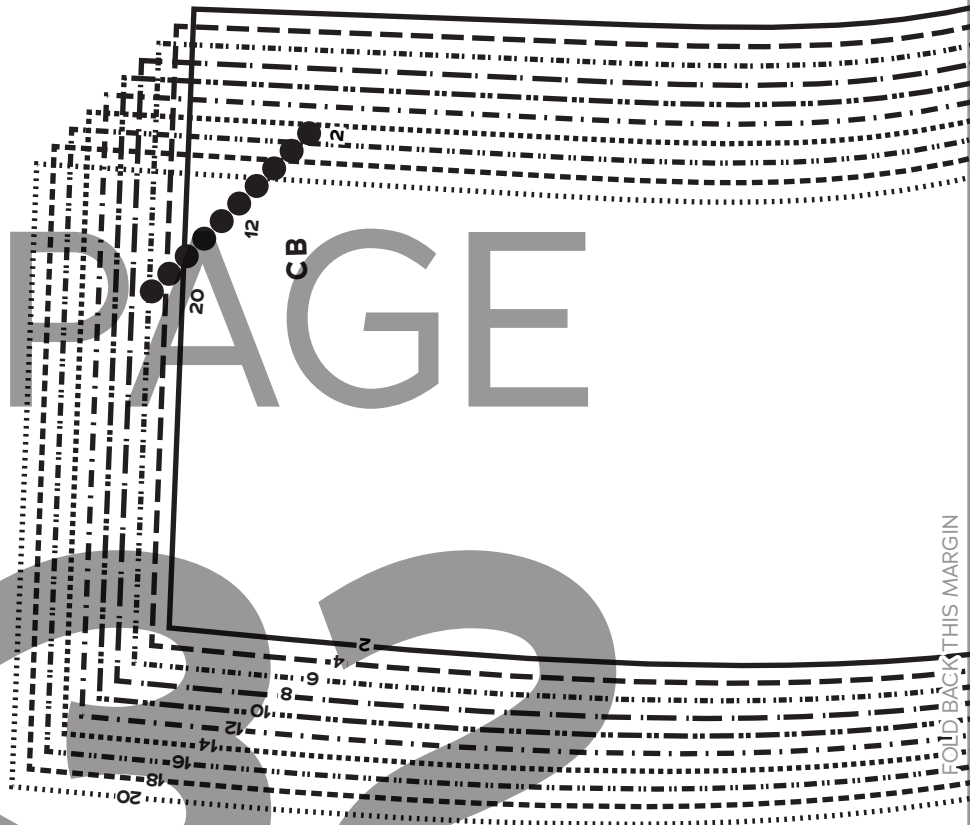

FOLD BACK THIS MARGIN

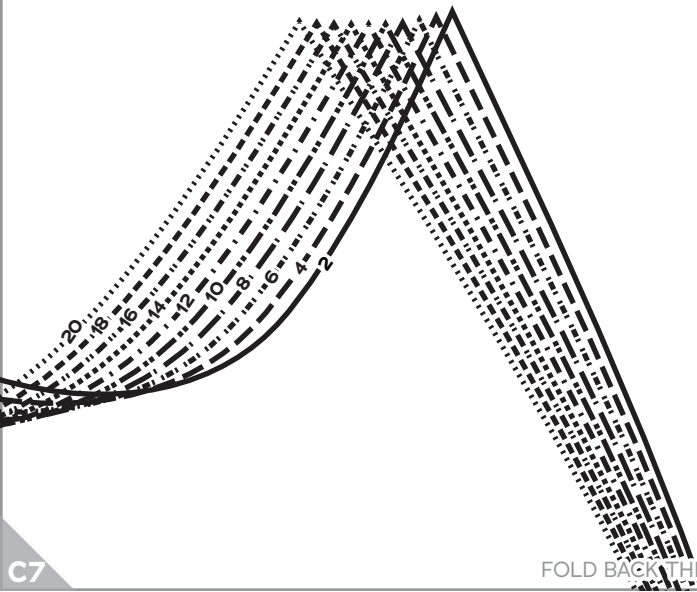

FOLD BACK THIS MARGIN

B8

B9



BY GERTIE

7 STUDY HALL DRESS SIZES 2-20

Collar

Cut 2 fabric, 2 interfacing

PAGE

33

FOLD BACK THIS MARGIN

C8

FOLD BACK THIS MARGIN

C9

B9

B10

PAGE

34

FOLD BACK THIS MARGIN

C9

FOLD BACK THIS MARGIN

C10

B10

B11

PAGE
35

FOLD BACK THIS MARGIN

FOLD BACK THIS MARGIN

C10

C11

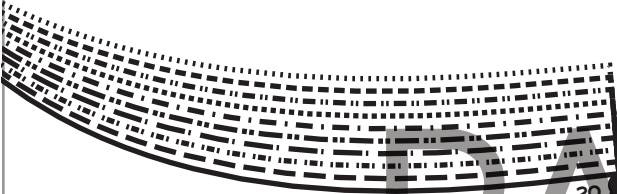

20
12
2

PAGE

36

Charm School
BY GERTIE

1 STUDY HALL
DRESS
SIZES 2-20

Dress Front,
D/DD Cup

Cut 1 fabric on fold

PAGE

37

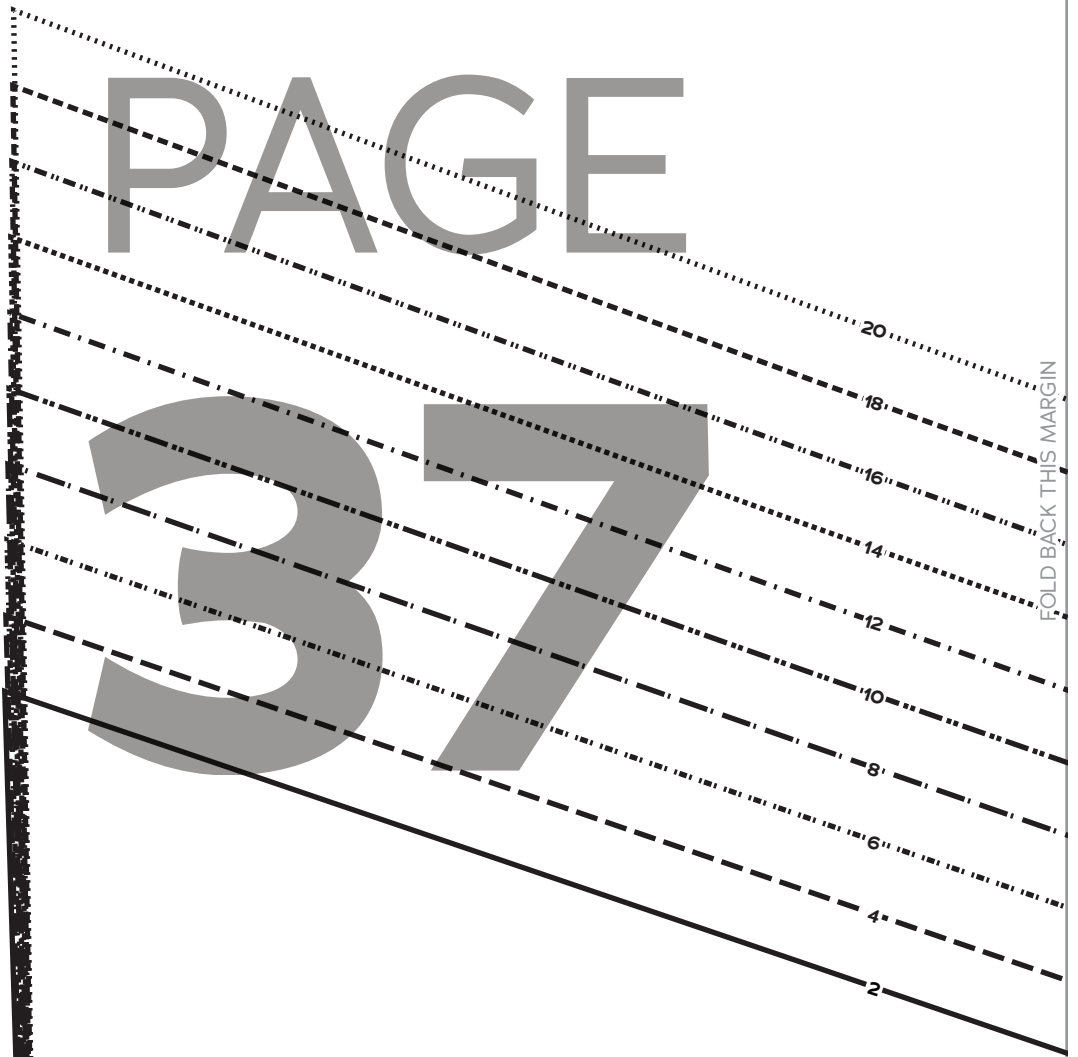

FOLD BACK THIS MARGIN

FOLD BACK THIS MARGIN

C1

C2

PAGE

38

FOLD BACK THIS MARGIN

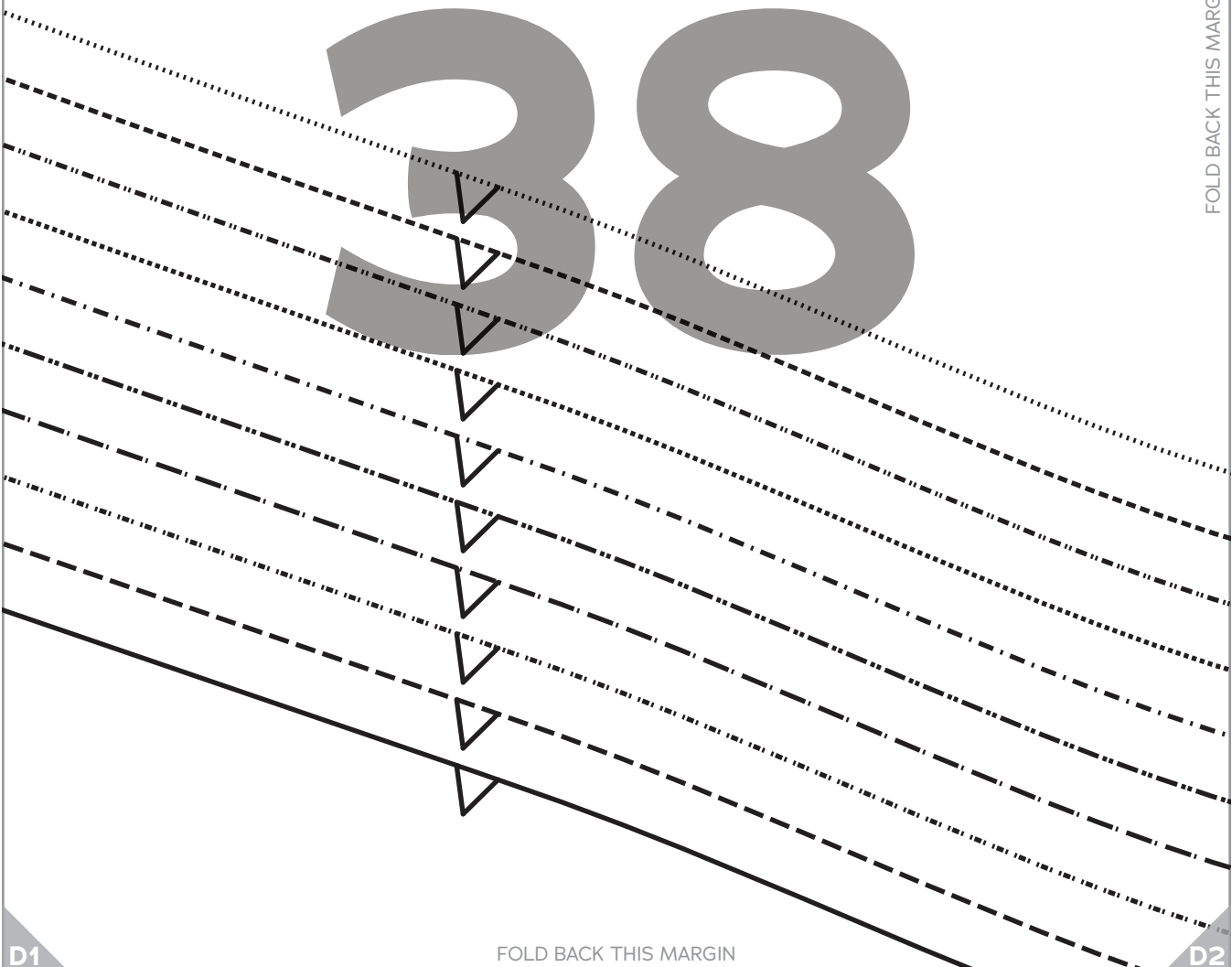

D1

FOLD BACK THIS MARGIN

D2

C2

C3

PAGE

39

FOLD BACK THIS MARGIN

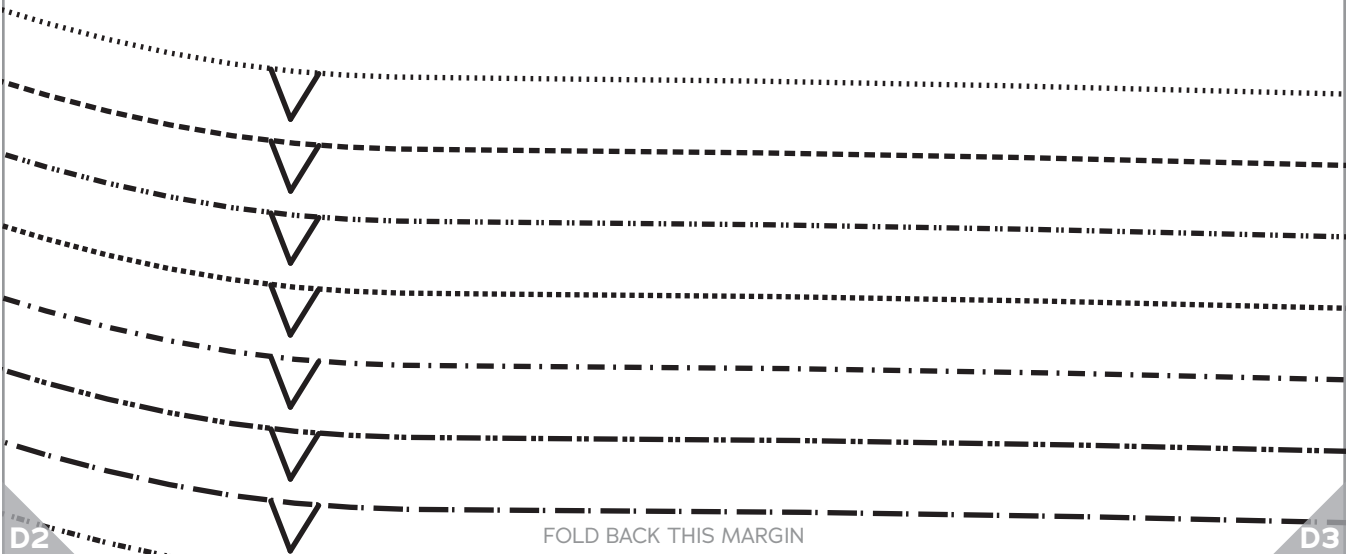

D2

FOLD BACK THIS MARGIN

D3

C3

C4

PAGE

40

FOLD BACK THIS MARGIN

FOLD BACK THIS MARGIN

D3

D4

C4

C5

PAGE

41

FOLD BACK THIS MARGIN

D4

FOLD BACK THIS MARGIN

D5

C5

C6

PAGE

42

FOLD BACK THIS MARGIN

D5

FOLD BACK THIS MARGIN

D6

C6

C7

PAGE 2

43

Charm School
BY GERTIE

STUDY HALL
DRESS
SIZES 2-20

Dress Side Front,
A Cup
cut 2 fabric

FOLD BACK THIS MARGIN

GRAINLINE

D6

FOLD BACK THIS MARGIN

D7

C7

C8

PAGE

44

FOLD BACK THIS MARGIN

POCKET
OPENING

FOLD BACK THIS MARGIN

D7

D8

C8

C9

PAGE

45

POCKET
OPENING

GRAINLINE

FOLD BACK THIS MARGIN

FOLD BACK THIS MARGIN

D8

D9

C9

C10

PAGE

46

FOLD BACK THIS MARGIN

D9

FOLD BACK THIS MARGIN

D10

C10

C11

PAGE

47

D10

FOLD BACK THIS MARGIN

D11

C11



PAGE

48

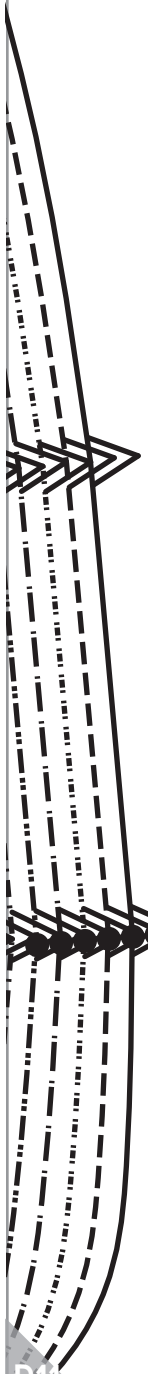

POCKET
OPENING



FOLD

D11

FOLD BACK THIS MARGIN

PAGE 49

FOLD BACK THIS MARGIN

FOLD BACK THIS MARGIN

D1

D2

← PAGE GRAINLINE →

50

POCKET
OPENING



FOLD BACK THIS MARGIN

E1

FOLD BACK THIS MARGIN

E2

D2

D3



STUDY HALL
DRESS
SIZES 2-20

Dress Side Front,

B/C Cup

Cut 2 fabric

PAGE

51

FOLD BACK THIS MARGIN



E2

FOLD BACK THIS MARGIN

E3

D3

D4

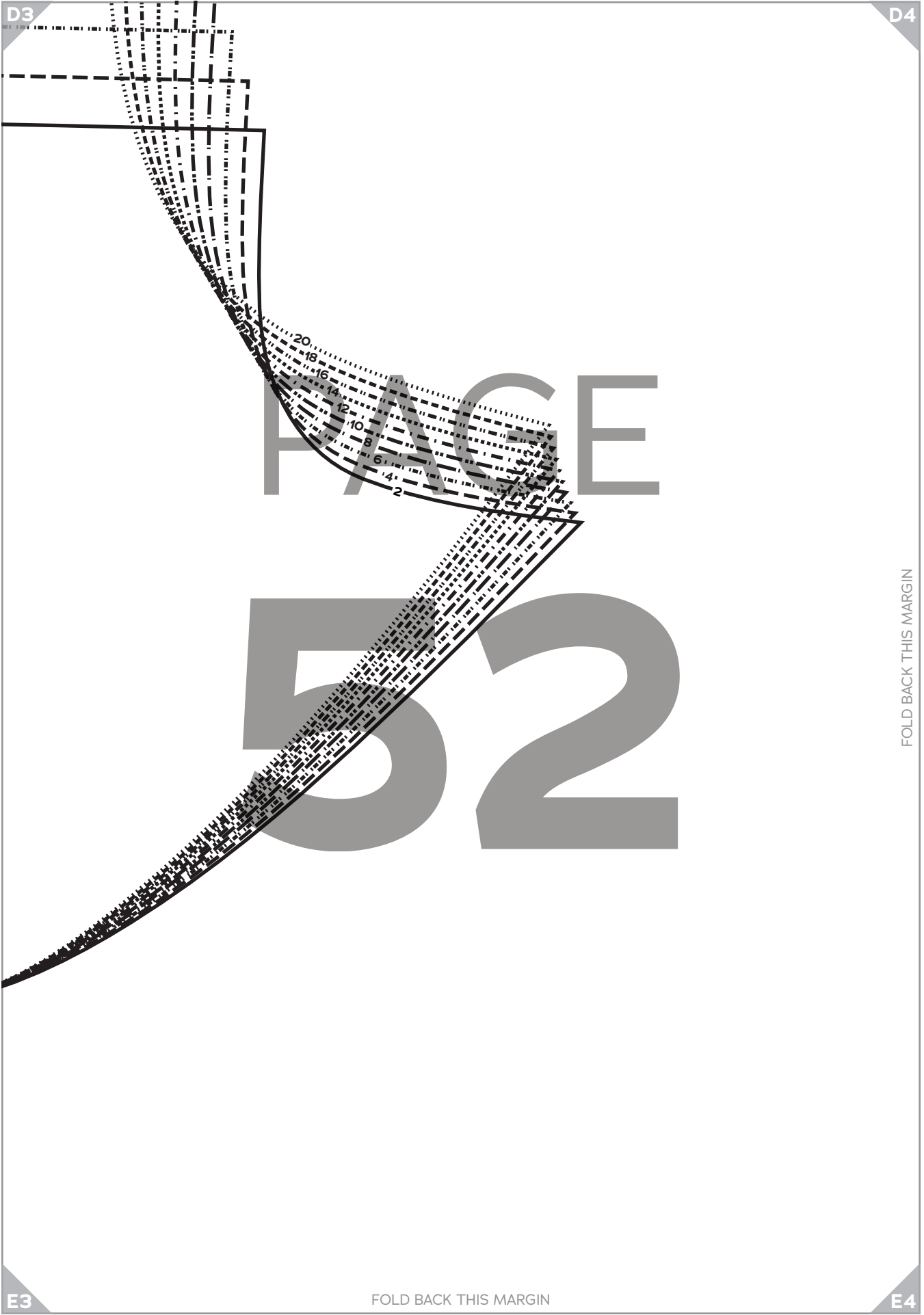

PAPER

52

FOLD BACK THIS MARGIN

E3

FOLD BACK THIS MARGIN

E4

D4

D5

PAGE

53

FOLD BACK THIS MARGIN

E4

FOLD BACK THIS MARGIN

E5

D5

D6

PAGE

54

FOLD BACK THIS MARGIN

E5

FOLD BACK THIS MARGIN

E6

D6

D7

PAGE

55

FOLD BACK THIS MARGIN

E6

FOLD BACK THIS MARGIN

E7

D7

D8

cut 2 fabric
 Dress Side Front,
 D/DD Cup
2
 STUDY HALL
 DRESS
 SIZES 2-20



PAGE

56

FOLD BACK THIS MARGIN

E7

FOLD BACK THIS MARGIN

E8

D8

D9

PAGE

57

FOLD BACK THIS MARGIN

E8

FOLD BACK THIS MARGIN

E9

D9

D10

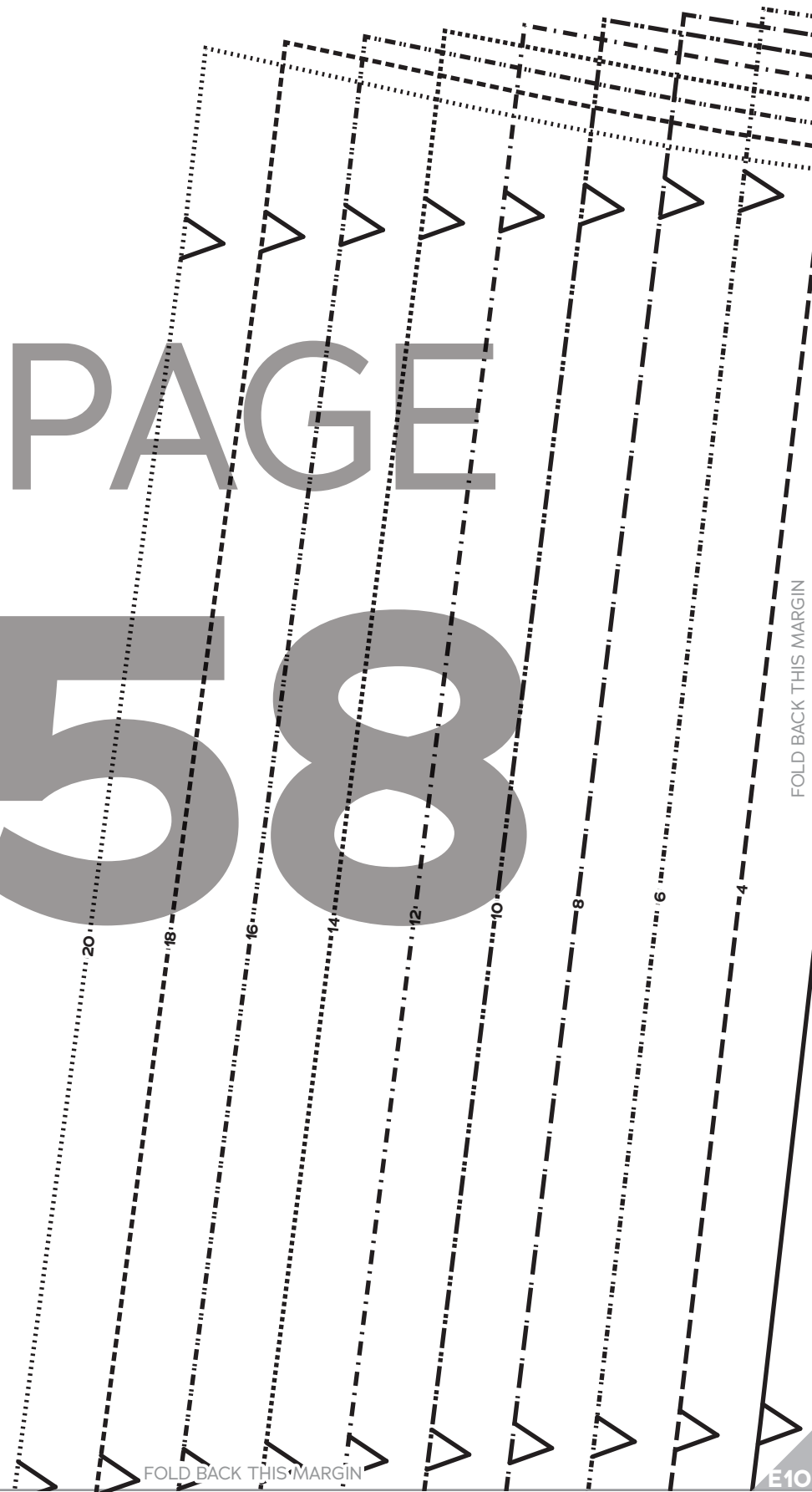

PAGE

58

20

18

16

14

12

10

8

6

4

FOLD BACK THIS MARGIN

FOLD BACK THIS MARGIN

E9

E10

D10

D11

2

PAGE 59

FOLD BACK THIS MARGIN

E10

FOLD BACK THIS MARGIN

E11

D11

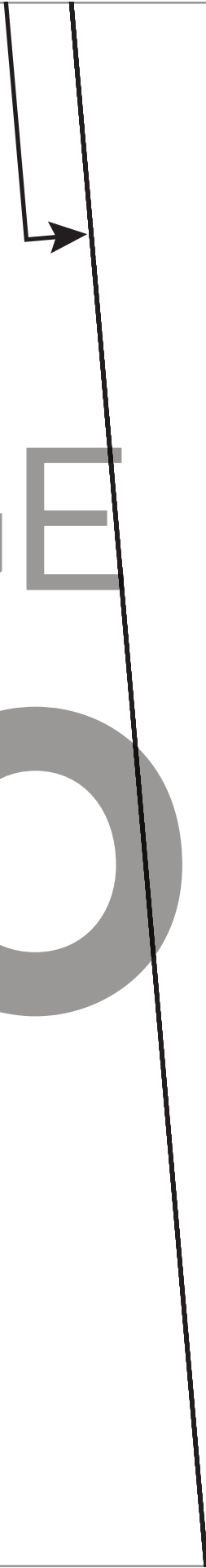

PAGE

60

E11

FOLD BACK THIS MARGIN

PAGE

61

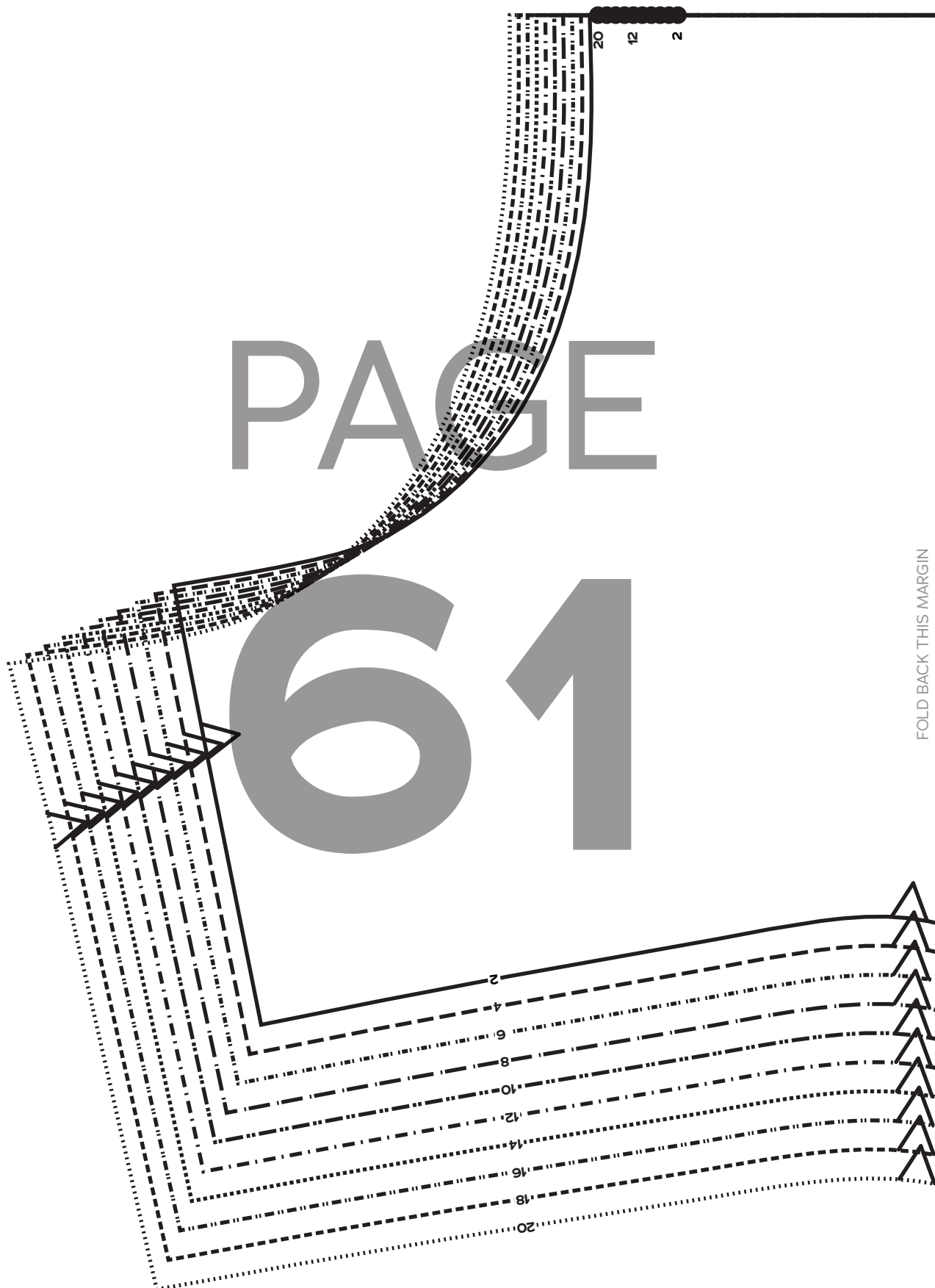

FOLD BACK THIS MARGIN

FOLD BACK THIS MARGIN

E1

E2

Charm School
BY GERTIE

STUDY HALL
DRESS
SIZES 2-20

1 Dress Front,
F/G Cup
Cut 1 fabric-on fold

PAGE

62

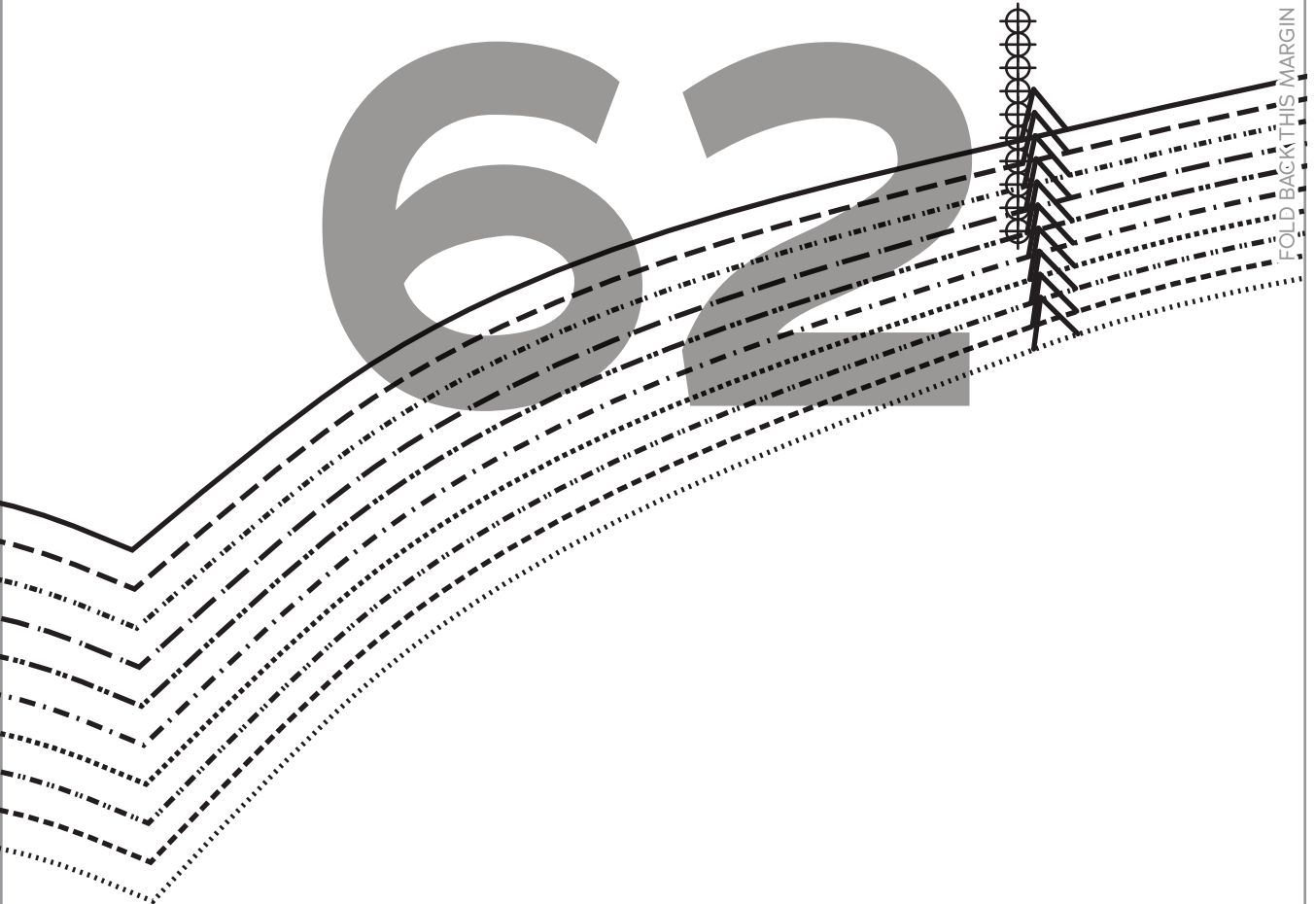

FOLD BACK THIS MARGIN

F1

FOLD BACK THIS MARGIN

F2

E2

E3

FOLD

PAGE

POCKET
OPENING

FOLD BACK THIS MARGIN

CUT ALONG THIS MARGIN

F2

FOLD BACK THIS MARGIN

F3

E3

E4



PAGE

64

FOLD BACK THIS MARGIN

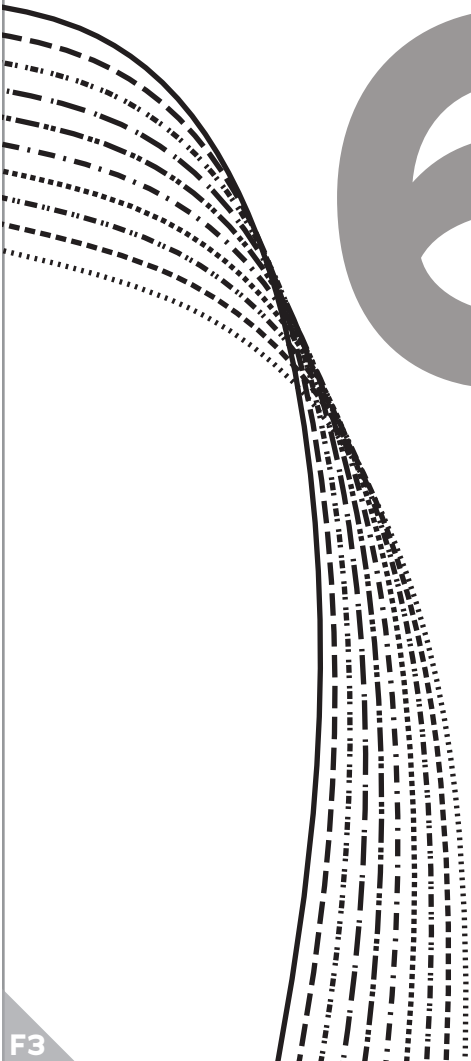

F3

FOLD BACK THIS MARGIN

F4

PAGE 65

FOLD BACK THIS MARGIN

E5

E6

PAGE

66

SHORT SKIRT CUTTING LINE

FOLD BACK THIS MARGIN

F5

FOLD BACK THIS MARGIN

F6

E6

E7

PAGE

67

20"

18"

16"

14"

12"

10"

8"

6"

4"

2"

FOLD BACK THIS MARGIN

FOLD BACK THIS MARGIN

F6

F7

E7

E8

PAGE

68

FOLD BACK THIS MARGIN

F7

FOLD BACK THIS MARGIN

F8

E8

E9

PAGE

69

FOLD BACK THIS MARGIN

FOLD BACK THIS MARGIN

F8

FOLD BACK THIS MARGIN

F9

E9

E10

PAGE

70

FOLD BACK THIS MARGIN

F9

FOLD BACK THIS MARGIN

F10

PAGE

71

SHOULD FOLD BACK THIS MARGIN

PAGE

72

T SKIRT CUTTING LINE

PAGE
73

FOLD BACK THIS MARGIN

FOLD BACK THIS MARGIN

F1

F2

PAGE

74

FOLD BACK THIS MARGIN

G1

FOLD BACK THIS MARGIN

G2

F2

F3

PAGE

75

FOLD BACK THIS MARGIN

FOLD BACK THIS MARGIN

G3

G2

F3

F4

PAGE

76

FOLD BACK THIS MARGIN

G3

FOLD BACK THIS MARGIN

G4

F4

F5

PAGE

77

FOLD BACK THIS MARGIN

G4

FOLD BACK THIS MARGIN

G5

F5

F6

PAGE

78

FOLD BACK THIS MARGIN

G5

FOLD BACK THIS MARGIN

G6

F6

F7

PAGE

79

FOLD BACK THIS MARGIN

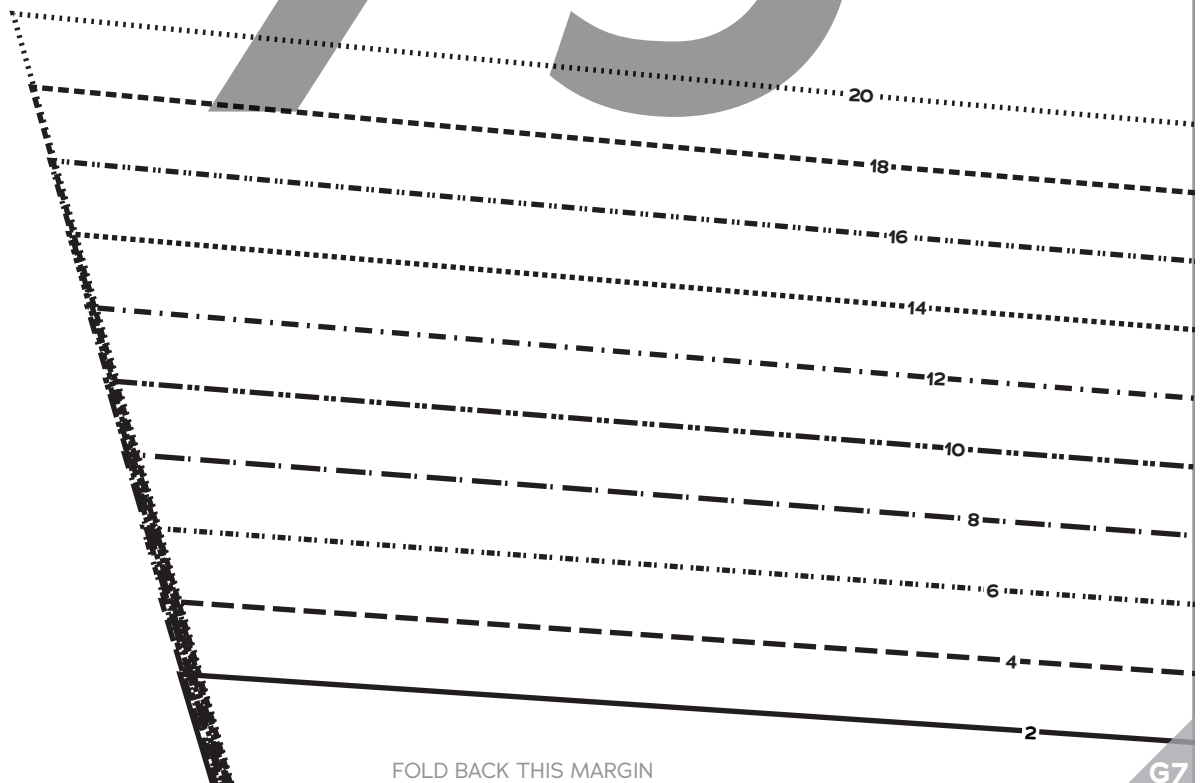

FOLD BACK THIS MARGIN

G6

G7

F7

F8

GRAINLINE

PAGE

POCKET
OPENING

80

FOLD BACK THIS MARGIN

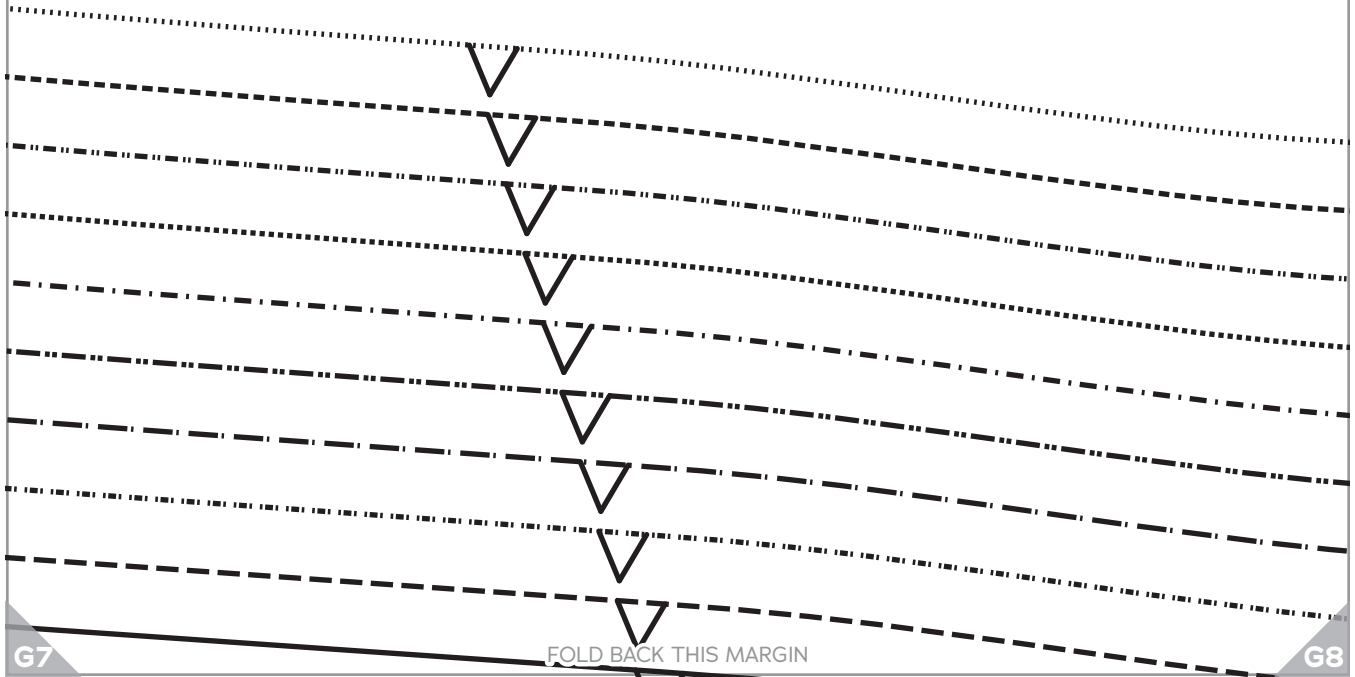

G7

G8

F8

F9



STUDY HALL
DRESS
SIZES 2-20

Dress Side Front,
F/G Cup
Cut 2 fabric

PAGE

81

FOLD BACK THIS MARGIN

FOLD BACK THIS MARGIN

G8

G9

F9

F10

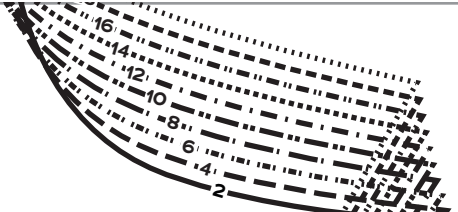

PAGE

82

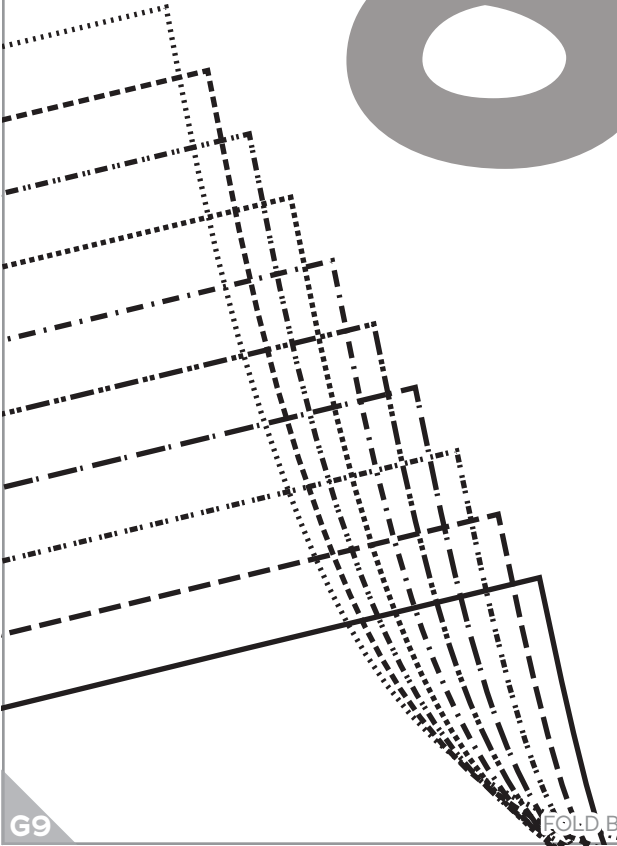

G9

FOLD BACK THIS MARGIN

PAGE
83

SHORT SKIRT CUTTING LINE

FOLD BACK THIS MARGIN

PAGE

84

FOLD BACK THIS MARGIN

G2

G3

PAGE 85

FOLD BACK THIS MARGIN



PAGE

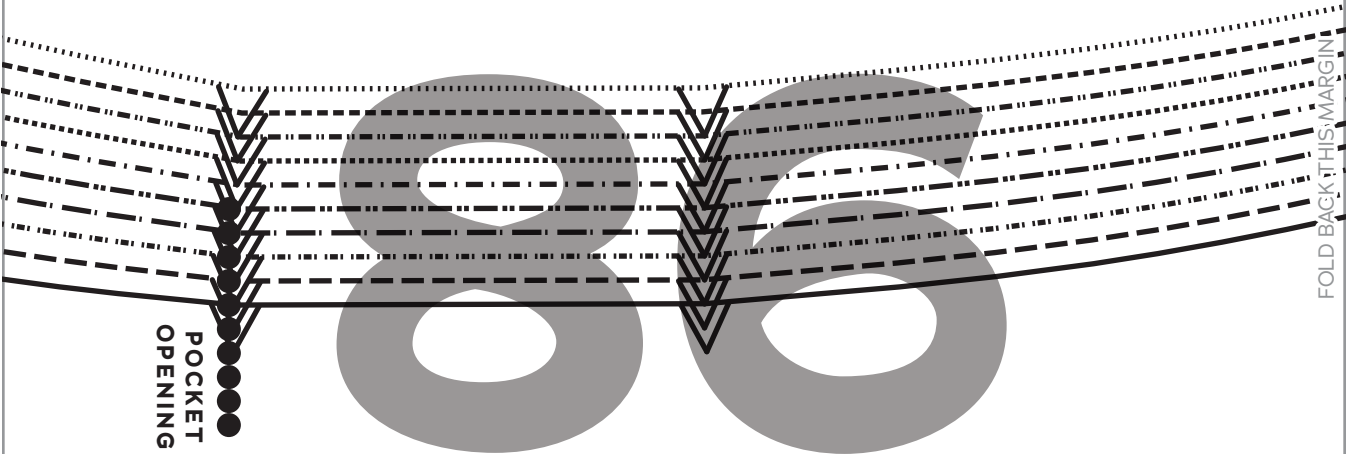

POCKET
OPENING

FOLD BACK THIS MARGIN

FOLD



PAGE

87



STUDY HALL
DRESS
SIZES 2-20

Dress Front,
H Cup

Cut 1 fabric on fold



FOLD BACK THIS MARGIN

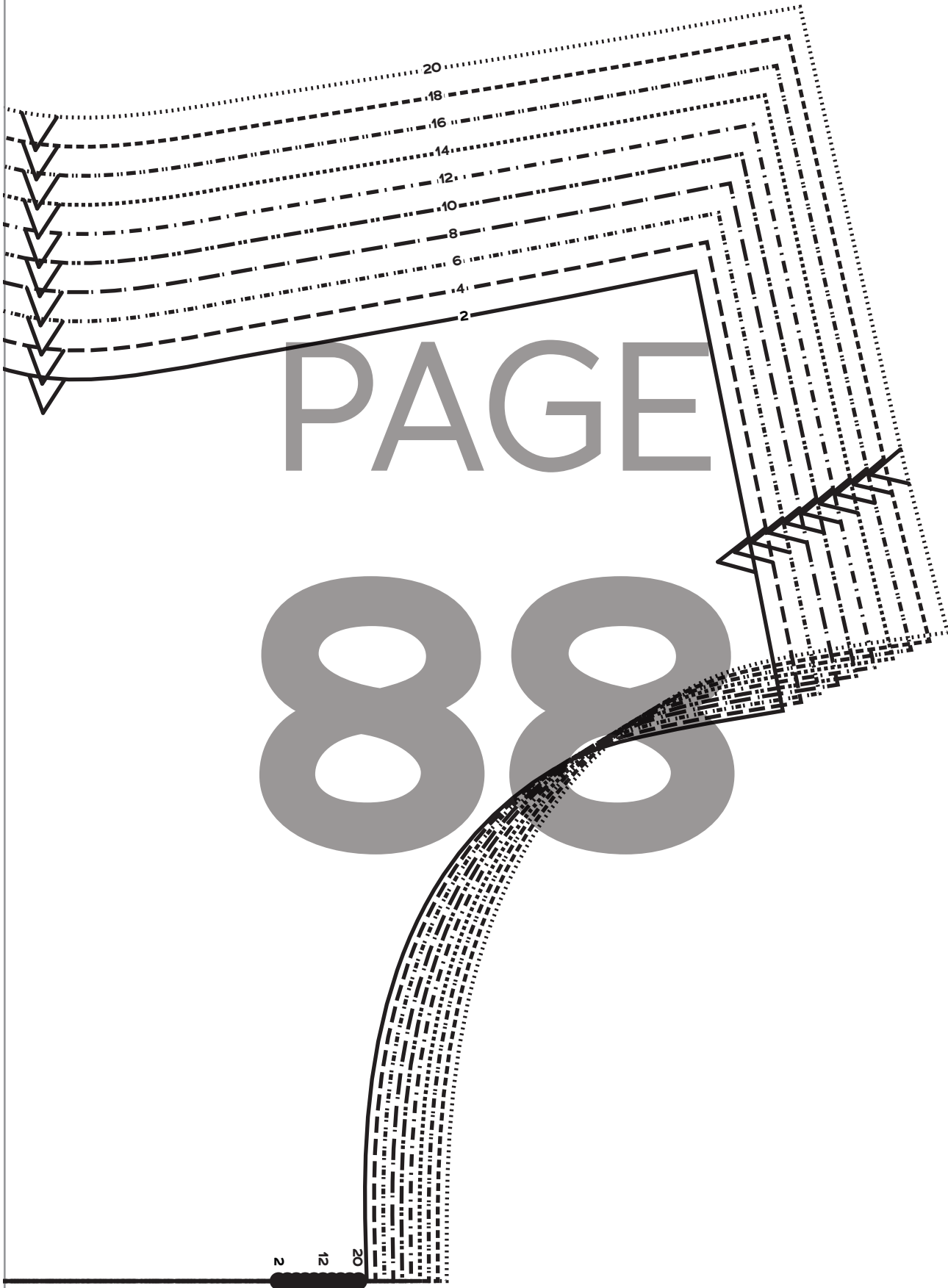

FOLD BACK THIS MARGIN

PAGE
89

FOLD BACK THIS MARGIN

G7

G8

PAGE

90

ONLINE

FOLD BACK THIS MARGIN

G8

G9

PAGE

91

POCKET
OPENING

FOLD BACK THIS MARGIN

GRA

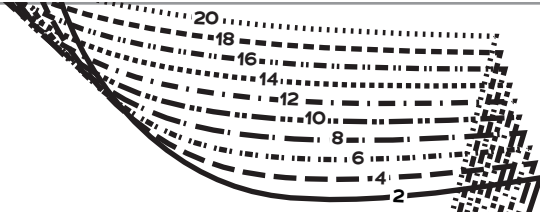

Charm School
 BY GERTIE
 STUDY HALL
2 STUDY HALL
 DRESS
 SIZES 2-20
 Dress Side Front,
 H CUP
 Cut 2 fabric

PAGE

92