

# Frenchy

## BABYDOLL EXPANSION

Sizes 18-34

5/8 inch (in) (1.5 cm) seam allowances are included on all pattern pieces.



SIZE 18-34  
PATTERN  
SIZE KEY

18	-----
20	.....
22	.....
24	-----
26	-----
28	-----
30	-----
32	.....
34	-----

SYMBOL KEY

grainline arrow



match point/  
placement mark



© 2023 Charm Patterns  
by Gertie. Distribution  
and Commercial Use  
Prohibited.

PAGE

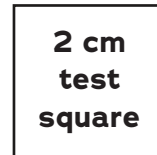
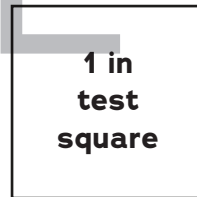

1

FOLD BACK THIS MARGIN

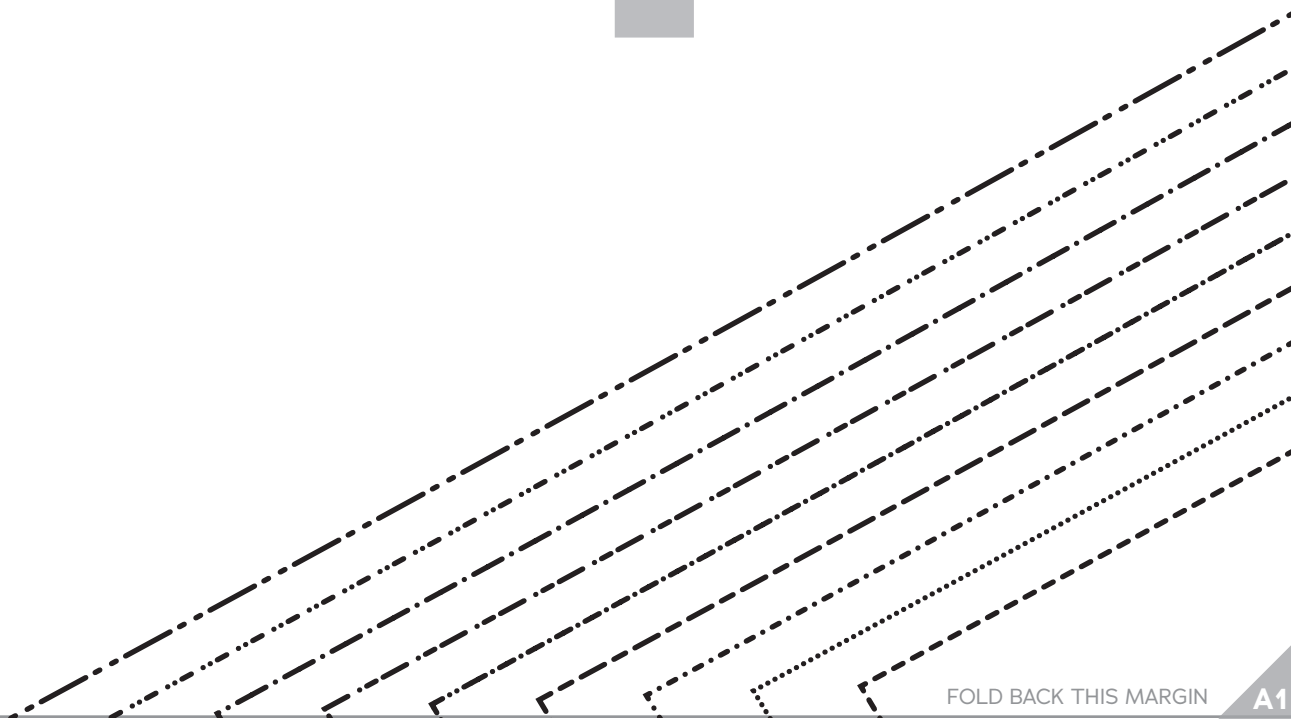

FOLD BACK THIS MARGIN

A1

# PAGE

# 2

FOLD BACK THIS MARGIN

A1

FOLD BACK THIS MARGIN

A2

PAGE

3

FOLD BACK THIS MARGIN

Society  
of CHARM  
**Frenchy**  
BABYDOLL  
EXPANSION  
SIZES 18-34

1  
Bloomer  
Front  
Cut 2 fabric

GRAINLINE

A2

FOLD BACK THIS MARGIN

A3

PAGE

4

A3

FOLD BACK THIS MARGIN

A4

PAGE

5

FOLD BACK THIS MARGIN

GRAINLINE

A4

FOLD BACK THIS MARGIN

A5

34  
32  
30  
28  
26  
24  
22  
20  
18

PAGE

6

FOLD BACK THIS MARGIN

*Society*  
of CHARM  
*Frenchy*  
BABYDOLL  
EXPANSION  
SIZES 18-34

2  
Bloomer  
Back  
Cut 2 fabric

A5

FOLD BACK THIS MARGIN

A6

PAGE

7

FOLD BACK THIS MARGIN

18  
20  
22  
24  
26

A6

FOLD BACK THIS MARGIN

A7

# PAGE

# 8

FOLD BACK THIS MARGIN

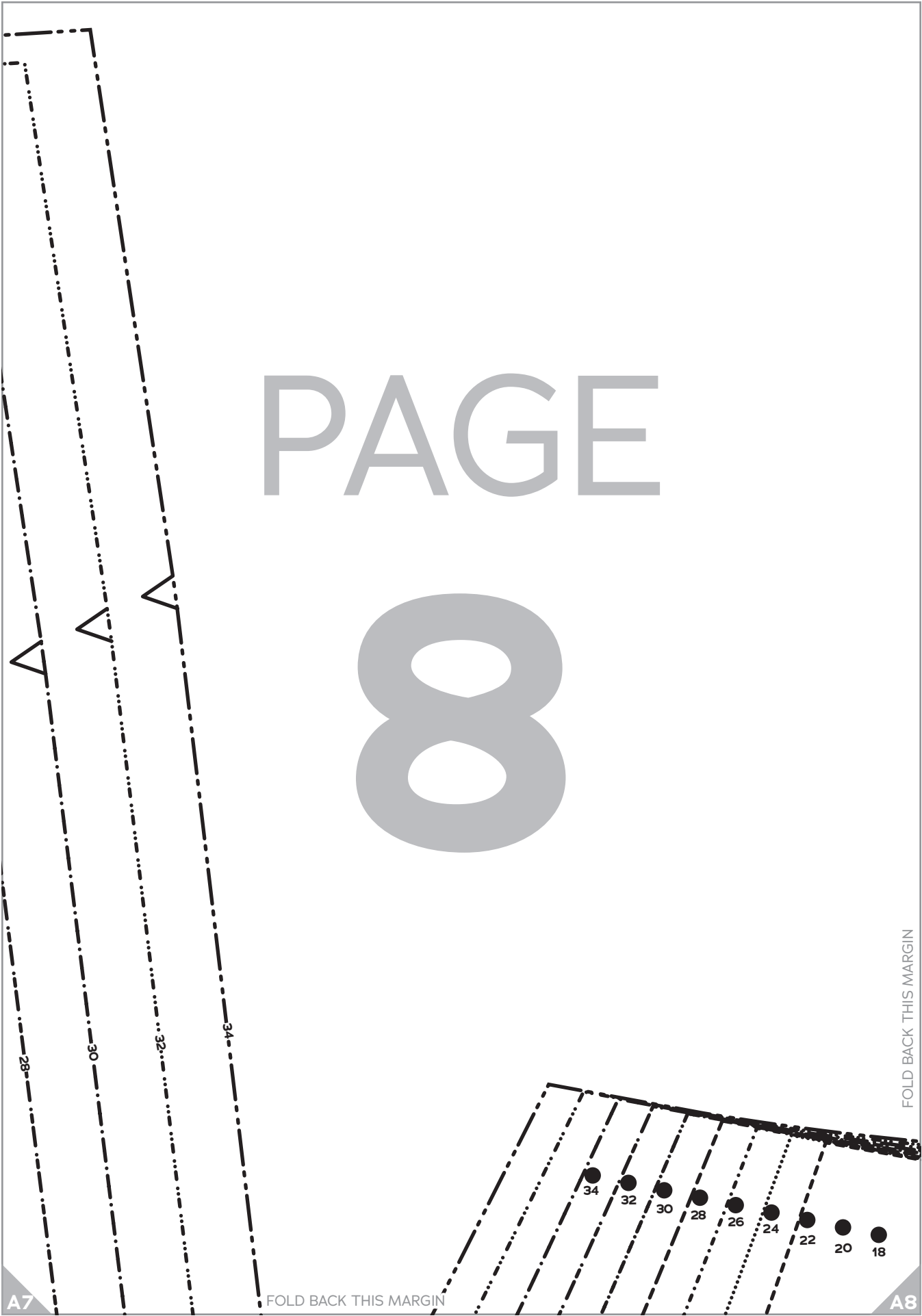

A7

FOLD BACK THIS MARGIN

A8



PAGE

9

FOLD BACK THIS MARGIN



A8

FOLD BACK THIS MARGIN

A9

PAGE

10



A9

FOLD BACK THIS MARGIN

FOLD BACK THIS MARGIN

A10

# PAGE

# 11

FOLD BACK THIS MARGIN

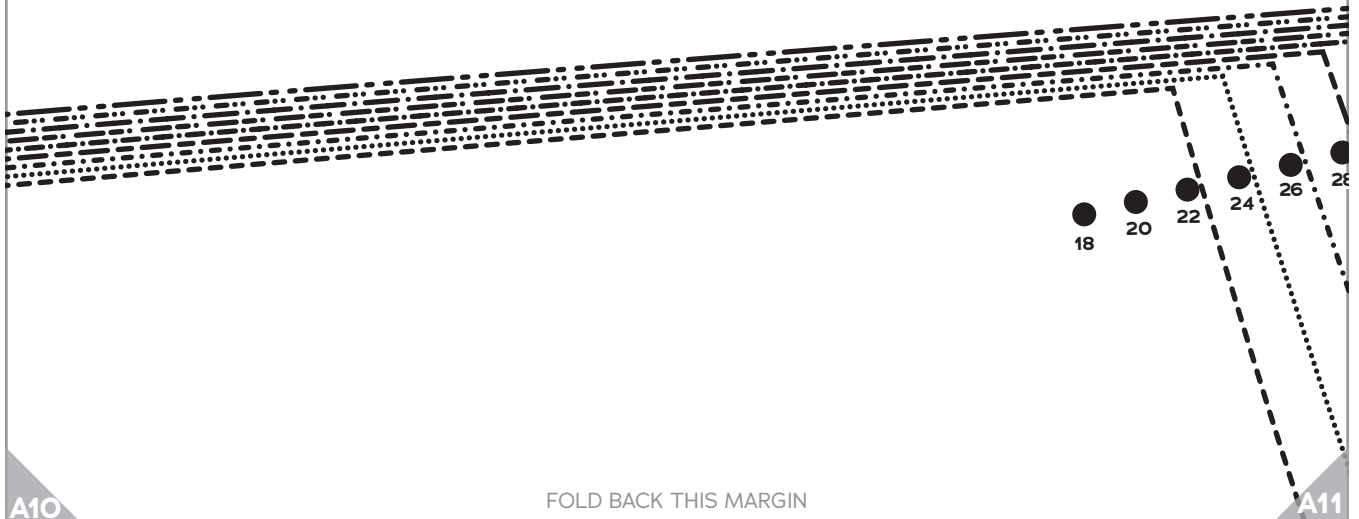

A10

FOLD BACK THIS MARGIN

A11

# PAGE

# 12

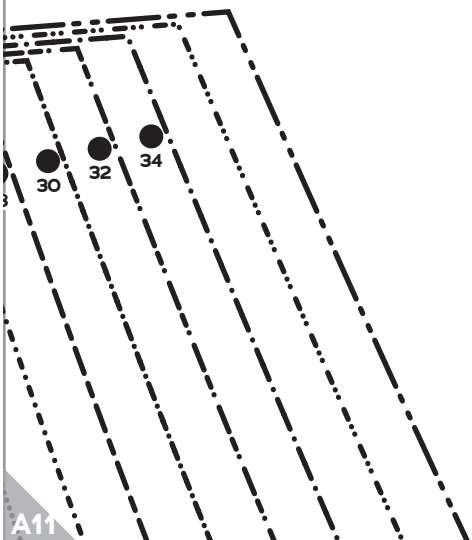

FOLD BACK THIS MARGIN

FOLD BACK THIS MARGIN

PAGE

13

PAGE

14

FOLD BACK THIS MARGIN

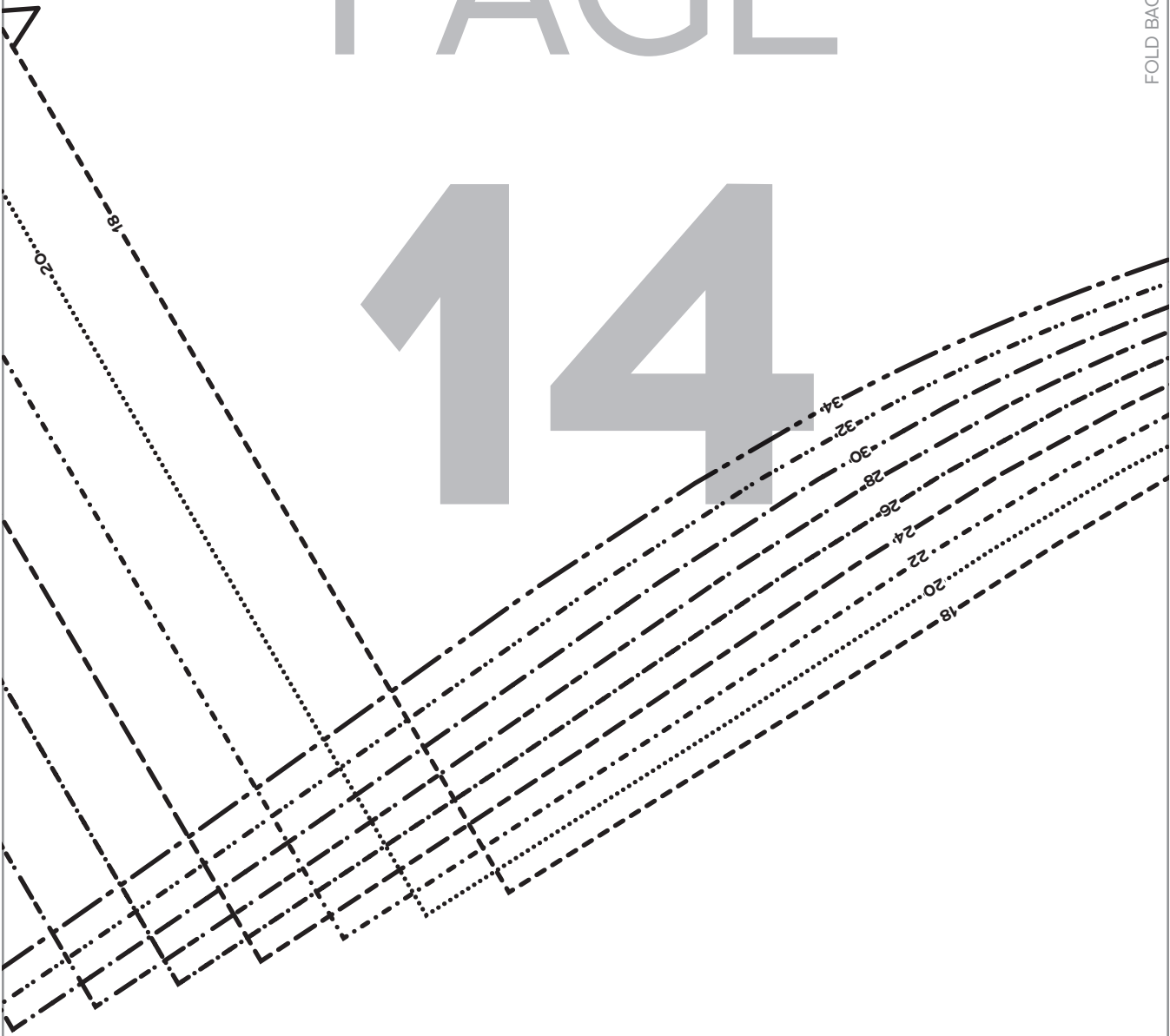

A2

A3



PAGE

FOLD BACK THIS MARGIN



PAGE

16

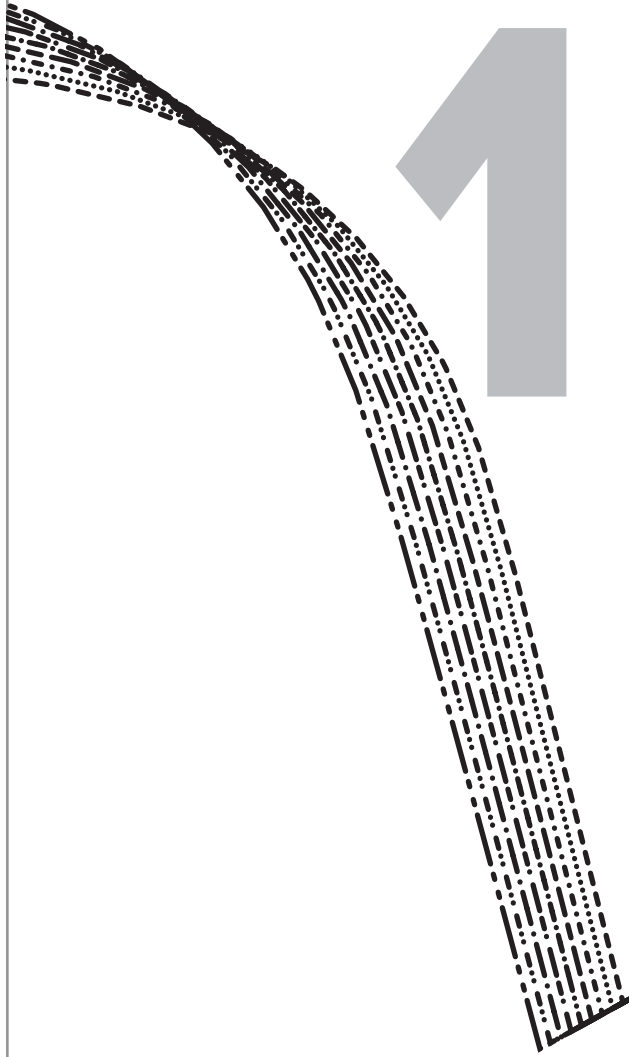





PAGE

17

FOLD BACK THIS MARGIN



PAGE

18

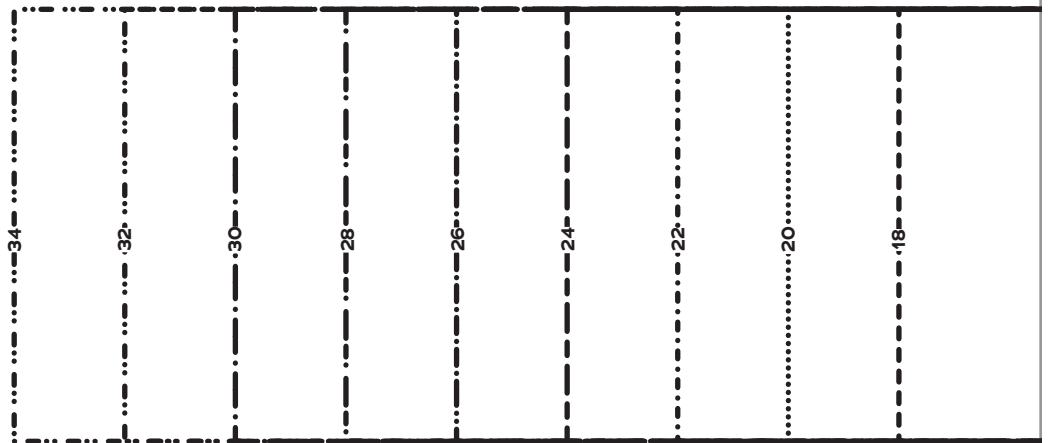

A6

A7

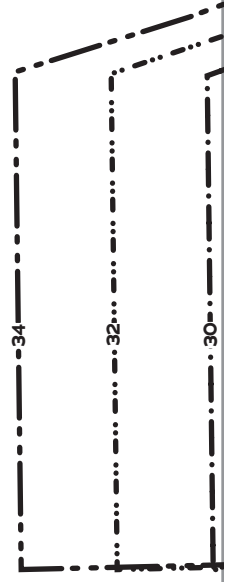
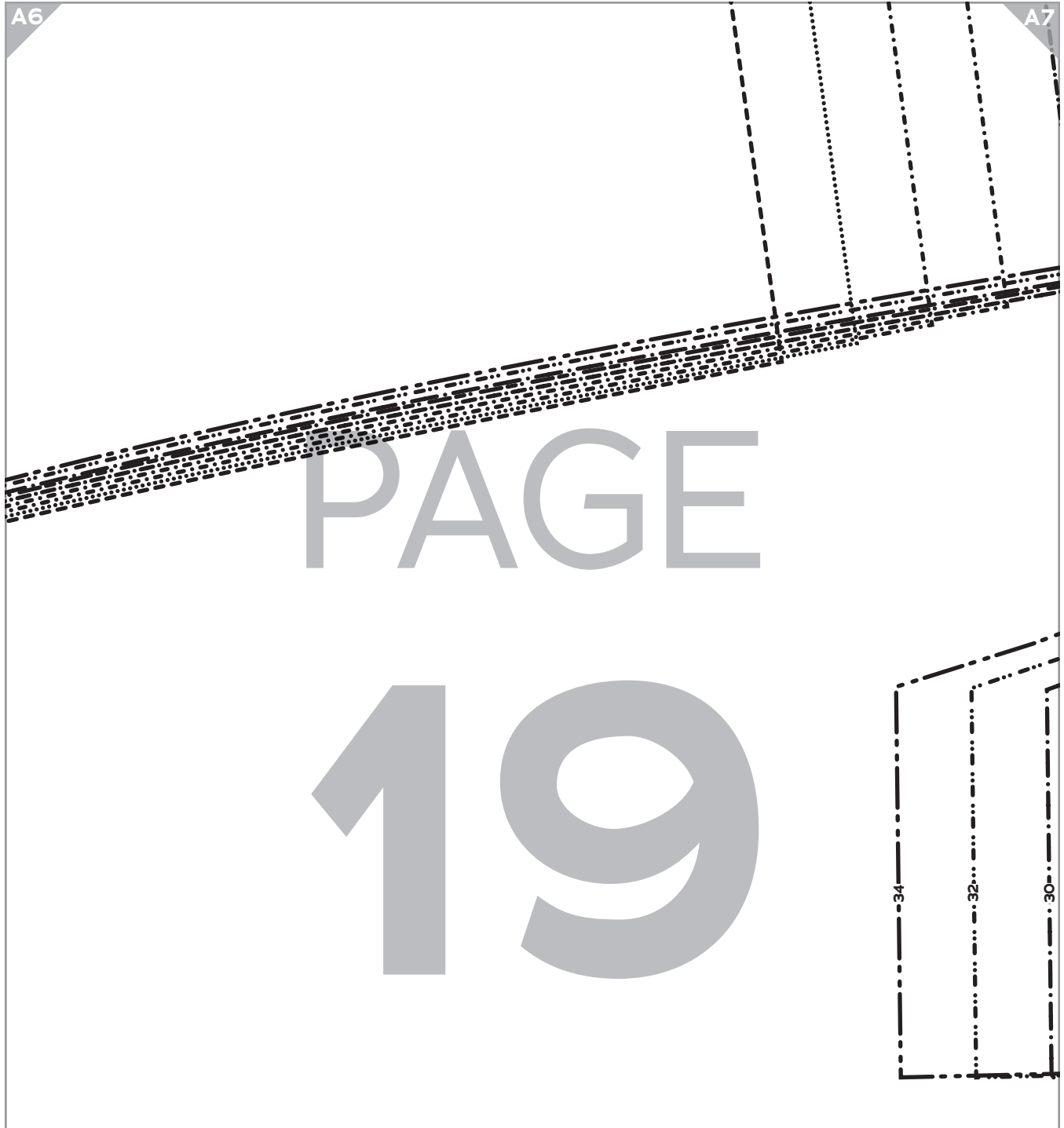

FOLD BACK THIS MARGIN

A7

A8

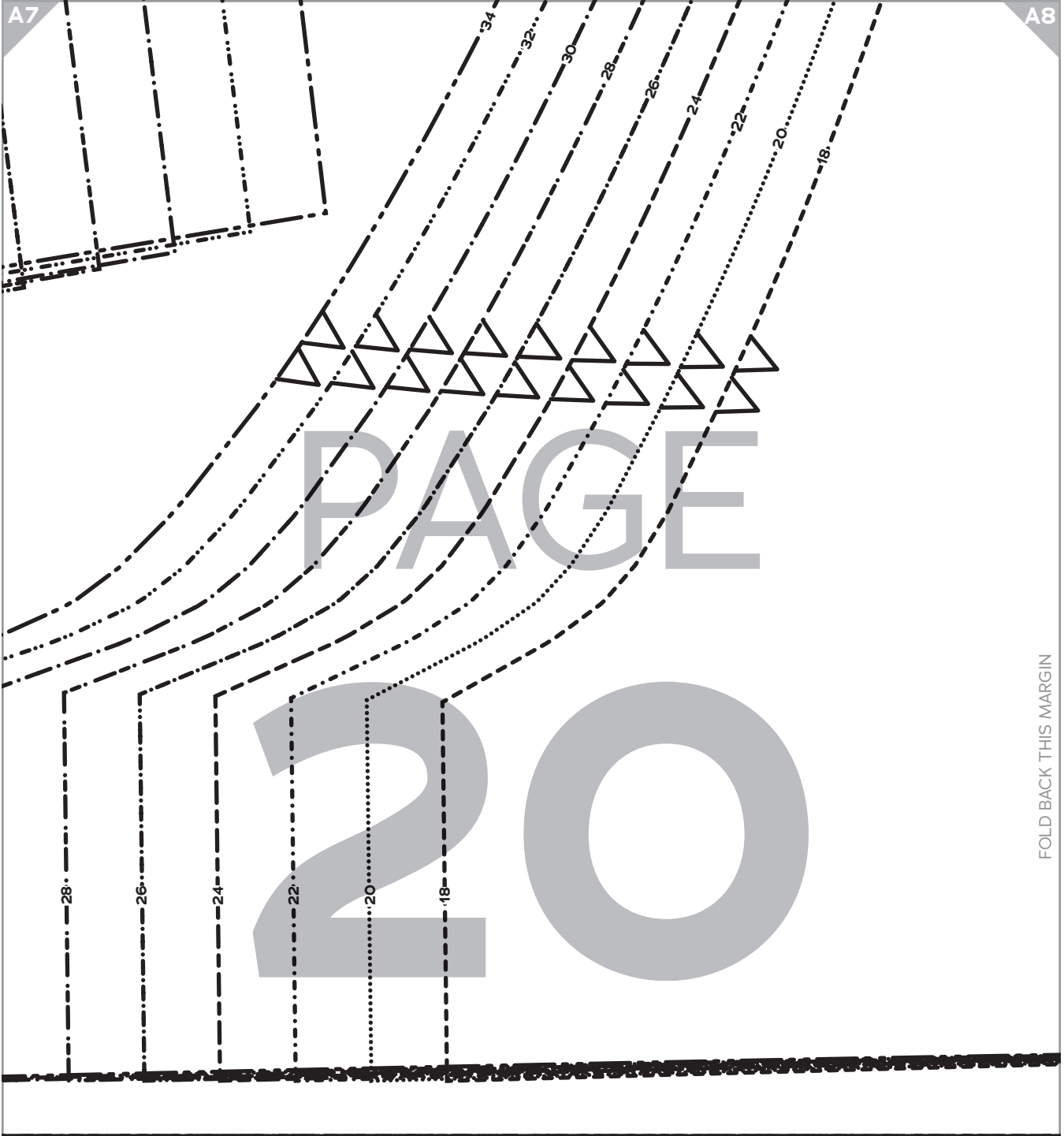

FOLD BACK THIS MARGIN

FRONT

GRAINLINE



PAGE

21

FOLD BACK THIS MARGIN

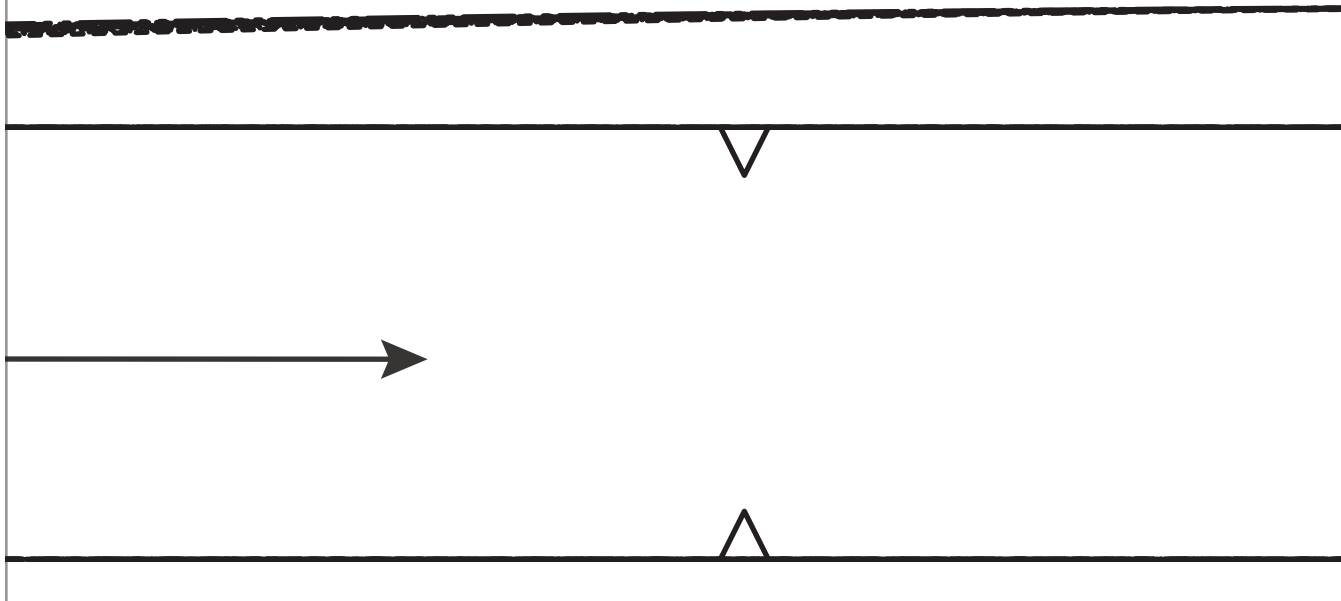

*Society*  
of CHARM  
*Frenchy*  
BABYDOLL  
EXPANSION  
SIZES 18-34

4

Peasant  
Sleeve  
Cut 2 fabric

PAGE

22

GRAINLINE

FOLD BACK THIS MARGIN

BACK

*Society*  
of CHARM  
*Frenchy*  
BABYDOLL  
EXPANSION  
SIZES 18-34

3

Bloomer  
Leg Binding  
Cut 2 fabric

# PAGE 23

FOLD BACK THIS MARGIN

A11

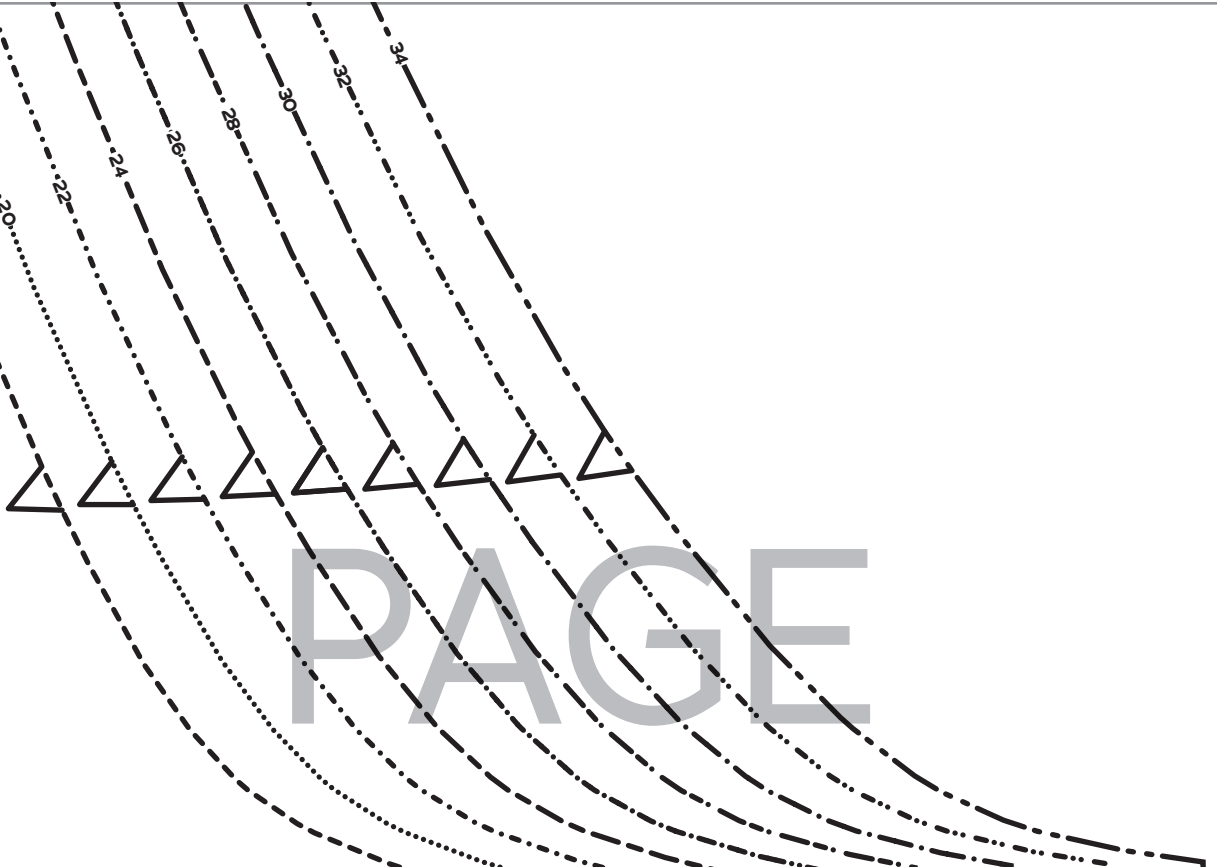

PAGE

24

